

THREE BIG DEVELOPMENTS

# Television

and *SHORT-WAVE WORLD*

1/-  
MONTHLY

MAY, 1937

No. 111. Vol. x.



**HOW TELEVISION  
IS RECEIVED IN  
GREATER LONDON**

**TELEVISION IN  
CORONATION WEEK**

**ACORN-VALVE  
RECEIVER**

**6D5 PUSH-PULL  
TRANSMITTER**

**TESTING AND  
OVERHAULING  
SHORT-WAVE SETS**

BERNARD JONES PUBLICATIONS LTD.  
CHANSITOR HOUSE, CHANCERY LANE  
LONDON W.C.2.

THE FIRST TELEVISION JOURNAL IN THE WORLD

# TELEVISION

## and SHORT-WAVE WORLD

### Special Features

	PAGE
America's Biggest Step in Television	260
Field Strength Measurements of the Alexandra Palace Transmissions ...	265
Defects in Magnetic Scanning ...	268
The First Acorn Valve Receiver ...	273
Television at the Ideal Home Exhibition ...	278
The Design of Vision-frequency Amplifiers ...	279
New Marconiphone Receiver ...	282
Photo-electric Effects ...	283
Super-power Transmitter for the Eiffel Tower ...	287
6D5 Push-pull Transmitter ...	293
Mains-operated S.W. Converter ...	297
Cheap Aerial Mast ...	302
Points in the Design of a 5-metre Super-het ...	304
Overhauling S.W. Receivers ...	305
Crystal Oscillators for the Beginner...	309
Series Anode Modulation and Speech-controlled Carrier ...	312

## COMMENT OF THE MONTH

### Publicising Television

THE B.B.C. have available a wonderful means of publicising television that if they will take advantage of it. Some months ago we suggested that it would be a good idea to broadcast the sound portion of the television programmes via the ordinary sound broadcast channels, and we were gratified later to learn that the suggestion had been taken up. Unfortunately the first broadcast of this nature that was made was a "flop," and instead of interesting the ordinary listener had the contrary effect of causing a certain amount of irritation—and all because there appeared to be no kind of accord between the sound broadcasts and the actual programme that was taking place at the Alexandra Palace. In the first place the programme was cut at a most inopportune moment which left listeners wondering what had happened and secondly, comment and explanation of the dual programme was of the most meagre nature. The second dual broadcast was but little better and in any case was not of sufficient merit to fire the ordinary listener with sufficient enthusiasm to desire the possession of a television receiver.

How these dual broadcasts could be made to have wonderful publicity value for television requires little imagination. Careful selection of programme matter, a clever compère to introduce the programme and convey the atmosphere of the studio, close co-operation with officials at Broadcasting House, and listeners to the sound programmes could be made to realise that here was real entertainment which they were missing. (The treatment that the first dual programme received seemed to indicate that there were interests antagonistic to television at work.

There is also another distinct advantage that would accrue from this type of broadcast, and this is the matter of economy. Many of the vision programmes could be made to lend themselves equally well for sound broadcasts, and would therefore result in a considerable saving.

### Three Big Developments

IN this issue we publish details of three important television developments abroad. The real significance of these to the television industry as a whole is that the utilitarian side of television has received further acknowledgment. (They mean that plans are being formulated for the practical use of television in two other countries, and they foreshadow a course which every other civilised country will be bound to follow within a comparatively short time. Such developments as these, by bringing more workers into the field, are bound to be of great assistance in the attainment of the degree of perfection that is the objective of the present comparatively small band of workers.

### TELEVISION AND SHORT-WAVE WORLD

*Proprietors :*  
**BERNARD JONES PUBLICATIONS, LTD**  
*Editor-in-Chief :*  
**BERNARD E. JONES.**  
*Editor :*  
**H. CORBISHLEY.**  
*Editorial, Advertising and Publishing Offices :*  
**Chansitor House, 38, Chancery Lane, London, W.C.2.**  
*Telephones :* Holborn 6158, 6159  
*Telegrams :* Beejapee, Holb., London.  
*Subscription Rates :* Post paid to any part of the world—3 months, 3/6; 6 months, 6/9; 12 months 13/6.  
 Published Monthly—1/- net.  
 (Last Wednesday in every month for following month).  
 Contributions are invited and will be promptly considered. Correspondence should be addressed according to its nature, to the Editor, the Advertisement Manager, or the Publisher, "Television and Short-wave World," Chansitor House, Chancery Lane, London, W.C.2.

### IMPORTANT

"Television and Short-wave World" is registered at the General Post Office, London, for transmission to Canada and Newfoundland by Magazine Post. Entered as Second-class mail matter, Boston, Mass.

# AMERICA'S BIGGEST STEP

## "OUT OF THE LABORATORY"

Through the courtesy of Mr. J. Vance Babb, of the National Broadcasting Company, itself a part of the Radio Corporation of America, of Radio City, New York, we are enabled to present our readers this month with some real information concerning the development and present position of television in the United States. The fact that in that great country radio is not co-ordinated as it is in Great Britain, but is in the hands of a number of separate companies who transmit on a purely commercial basis, has very considerably influenced the question and the manner of the introduction of a television service. That service can come only from stations—widely separated over an immense territory—who must look to sponsored programmes for their income. And it follows that the development of television in the United States must be on remarkably interesting lines.

AN ACCOUNT OF THE RECENT TELEVISION ACTIVITIES OF THE NATIONAL BROADCASTING COMPANY AND RADIO CORPORATION OF AMERICA

FOR over ten years the Radio Corporation of America has been conducting research towards the development of a practical system of high definition television with the result that many of the fundamental principles which are now generally employed have been due to the research engineers of this concern. Among the names of these engineers are those of Zworykin, Joliffe, Engstrom, Epstein, Kell, Bedford and Trainer—names which are well known in television circles all over the world.

In the course of their studies the research engineers of R.C.A. have thoroughly investigated all the different methods by which television may be accomplished, including scanning disc, flying spot, cathode-ray devices and other methods.

### Early Experiments

Prior to 1932 there was in operation in the research laboratories in Camden, N.J., a system of television which brought mechanical scanning to what was then believed to be the highest level then obtainable in any system. In the receiving portion of this system a cathode-ray tube was used. On the basis of this work it was decided in 1932 to install in New York City a transmitter using this mechanical system of scanning. At that time it was known that it was necessary to use ultra-high frequencies to obtain the picture quality then possible, and consequently the transmitter was built to operate on a frequency above 40,000 kc. This was the first full scale television broadcast transmitter in the U.S.A. for relatively high definition images. The experimental operation of this transmitter provided information on many of the transmitter problems, one



General view of the N.B.C. experimental studio in the R.C.A. building. The "camera-men" are focusing Iconoscopes, and the microphone is swinging into position.

of which was the difficulty of serving a city such as New York.

While this transmitter was being used for the purpose of collecting data on the transmission problems, R.C.A. engineers in Camden were concentrating on a system of television based on electronic scanning in order to overcome the limitations of the mechanical system which had been made apparent by the New York tests. In 1933 there was put into operation in the laboratory in Camden, N.J., a new type of transmitter which employed electrical scanning, a greater number of lines, and other improvements. By 1934 this system had developed into one employing 343 lines interlaced with a frame frequency of 30 per second and a field frequency of 60 per second. A decision was made to test this system in the field by establishing facilities in New York City.

During 1935 work was undertaken in preparation for this experimental field test in New York so that practical experience could be obtained on technical problems, apparatus, programmes, and considerations of television system standards. Tests of the R.C.A. system began on June 29, 1936, with an organised programme of experiments between a high-power transmitting station fully equipped for studio and film programmes and receivers in a number of centres throughout the New York area. Live talent and motion pictures were successfully transmitted.

# IN TELEVISION AND INTO THE FIELD"

PRESIDENT N.B.C.

## Television Studios

The television studios are located in the R.C.A. Building with complete facilities for direct pick-up and film programmes. The vision signals are transferred to the transmitter in the Empire State Building either by coaxial cable or radio relay. The vision and audio transmitters are located on an upper floor of the Empire State Building, with a common aerial at the very top. The vision transmitter carrier frequency is 49.75 megacycles, and the audio transmitter carrier frequency is 52 megacycles. The radio relay channel between the R.C.A. and Empire State Building operates on 177 megacycles.

This experimental system used 343 lines per frame, interlaced, with a frame frequency of 30 per second and a field frequency of 60 per second. Synchronisation at the receivers is by transmitted impulses. The horizontal and vertical synchronising impulses are of the same amplitude using wave shape selection.

The demonstration possessed four features not included in previous demonstrations of television. It was the first made by R.C.A. and the National Broadcasting Company for the press under practical working conditions, although previous demonstrations of laboratory television have been given. It represented the first showing of a complete programme built for entertainment value as well as a demonstration of transmission. It also included the first showing of a new 12-in. receiving tube, which reproduces a picture on a 7½-in by 10-in. screen.

The demonstration was presented and supervised by Ralph R. Beal, R.C.A. Research Supervisor; O. B. Hanson, N.B.C. Chief Engineer, and Charles W. Horn, N.B.C. Director of Research and Development. These engineers explained that numerous problems of trans-



N.B.C.'s television announcer, Betty Goodwin, as she appears in 441-line transmission.



R.C.A.'s famous Iconoscope, the tube which transforms what it "sees" into electric impulses. In the background is the well-known N.B.C. microphone.

mission and production will still remain to be solved before television on a commercial scale can be attempted.

The demonstration was the first for the press of R.C.A. experimental television under practical field conditions since the Radio Corporation of America assigned the task of setting up a television operating plant to the National Broadcasting Company.

This assignment included the construction of studios adapted to television technique, the installation of equipment in those studios and at the transmitter atop the Empire State Building, the determination of workable engineering methods for the transmission of pictures, and the training of a staff to take over the operation of the plant.

## Future of Television in U.S.A.

Mr. Lenox R. Lohr, President of the National Broadcasting Company, introducing Mr. Sarnoff on this occasion said "The rôle of the National Broadcasting Company in television will be operating transmitters, programming and, when it becomes available for commercial use, securing sponsors. In order that we may be prepared to do our part, our engineers are daily putting apparatus on the air under practical service conditions. Our programme department is learning an entirely new technique in continuity writing, make-up, staging, and a multitude of other details which this new art will demand. It is experimenting with commercial programmes to determine the effectiveness of television to sell goods.

"Our engineers are studying the economics of networking, so that several stations may be interconnected by either coaxial cable or short-wave relays, and are developing equipment for the making of outside pick-ups. With the experience that we are gaining daily, we feel that when the time is ripe to offer television to the public, the National Broadcasting Company will be

## PROBLEMS OF DISTRIBUTION IN U.S.A.

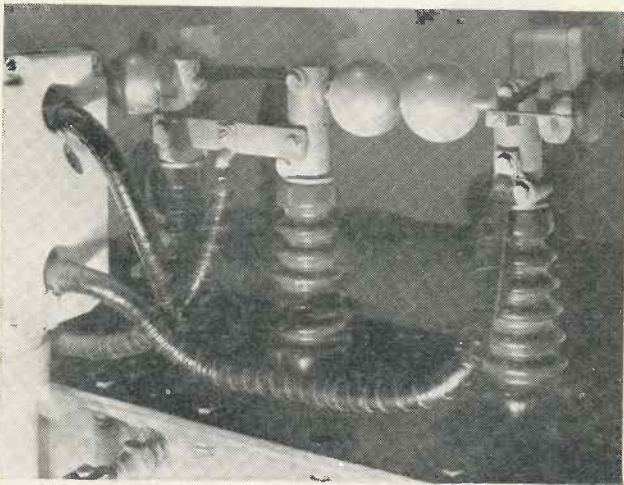

*The two balls on a modulation transformer form a safety discharge gap for heavy overloads of current that might otherwise damage valuable equipment.*

prepared to do its part. Results which you will see are largely due to the vision and enterprise of Mr. David Sarnoff, President of the Radio Corporation of America."

Mr. David Sarnoff, President, Radio Corporation of America, speaking to the visitors, said: "June 29 (1936) marked the beginning in this country of organized television experiments between a regular transmitting station and a number of homes. Since then we have advanced, and are continuing to advance, simultaneously along the three broad fronts of television development—research which must point the road to effective transmission and reception; technical progress which must translate into practical sets for the home the achievements of our laboratories; and field tests to determine the needs and possibilities of a public service that will ultimately enable us to see as well as to hear programmes through the air. On all these fronts our work has made definite progress and has brought us nearer the desired goal.

"As you know, we have been transmitting from our television station on top of the Empire State Building in New York City, which is controlled from the N.B.C. television studios in the R.C.A. Building. We have observed and measured these transmissions through a number of experimental receivers located in the metropolitan area and adjacent suburbs. The results thus far have been encouraging, and instructive. As we anticipated, many needs that must be met by a commercial service have been made clear by these tests.

"We have successfully transmitted through the air, motion pictures as well as talent. The distance over which these television programmes have been received has exceeded our immediate expectations. In one favourable location due to the extreme height of our transmitter, we have consistently received transmissions as far as 45 miles from the Empire State Building.

"The tests have been very instructive in that we have learned a great deal more about the behaviour of ultra-short waves and how to handle them. We know more about interferences, most of which are man made and susceptible of elimination. We have sur-

mounted the difficulties of making apparatus function outside of the laboratory. We have confirmed the soundness of the technical fundamentals of our system, and the experience gained through these tests enables us to chart the needs of a practical television service.

"While we have thus proceeded on the technical front of television, the construction and preparation of television studios have enabled us to co-ordinate our technical advance with the programme technique that a service to the home will ultimately require. Under the direction of the President of the National Broadcasting Company, Mr. Lenox Lohr, the N.B.C. has instituted a series of television programme tests in which we have sought to ascertain initial requirements.

"One of the major problems in television is that of network syndication. Our present facilities for distribution of sound broadcasting cover the vast area of the United States and serve its 128,000,000 people. Similar coverage for television programmes, in the present state of the television art, would require a multiplicity of transmitters and network interconnection by wire or radio facilities still to be developed.

"Our programme is three-fold; first, we must develop suitable commercial equipment for television and reception; second, we must develop a programme service suitable for network syndication; third, we must also develop a sound economic base to support a television service.

"From the standpoint of research, laboratory development, and technical demonstration, television progress in the United States continues to give us an unquestioned position of leadership in the development of the art.

"We are now engaged in the development of studio and programme techniques that will touch upon every possibility within the growing progress of the art. The distinction between television in this country and abroad is the distinction between experimental public



*Fashion model being made up according to television's special and exacting requirements by an expert.*

## SPONSORED PROGRAMMES IN U.S.A.

services undertaken under government subsidy in countries of vastly smaller extent, and the progressive stages of commercial development undertaken by the free initiative, enterprise and capital of those who have pioneered the art in the United States. While the problems of television are formidable, I firmly believe they will be solved."

#### 441-line Definition

In co-operation with other concerns engaged in the development of television, R.C.A. recommended to the Federal Communications Commission the adoption of standards including images of 441-lines and a video-audio carrier spacing of approximately 3.25 megacycles and the R.C.A. field test system was consequently changed to conform to these standards, and the following is an account of the results obtained.

The first tests of high definition television using the new standards commenced in January of this year and were conducted by engineers of the Radio Corporation of America and the National Broadcasting Company.

Images scanned by the R.C.A. Iconoscope, the pick-up tube, at the rate of 441 lines per frame have been transmitted from the N.B.C. experimental station in the Empire State Tower and successfully received by a selected number of experimental television receivers in the homes of R.C.A.-N.B.C. engineers and technicians. The pictures obtained on 441-line definition are much superior to those of 343 lines.

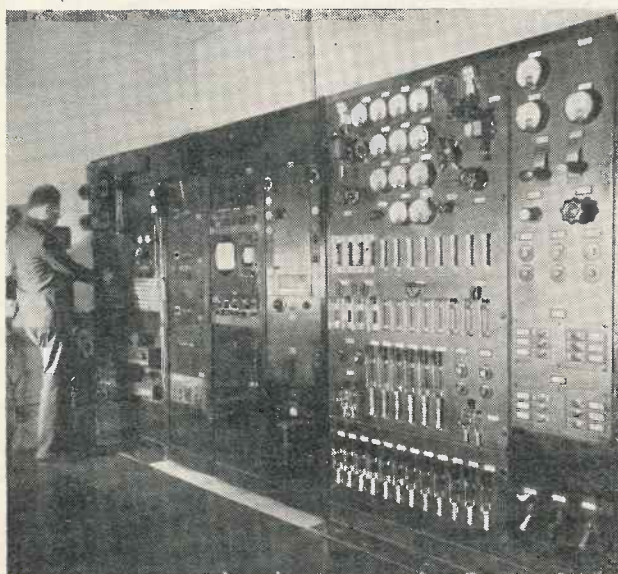

*The engineer is standing before the sound rack. In the third panel are small buttons controlling television images.*

In reviewing the progress of the Radio Corporation of America for the first three months of 1937, Mr. David Sarnoff, president, had the following to say:—

"Many improvements have resulted from the field tests of the R.C.A. television system which are being continued. The requirements of a nation-wide television service must be viewed from the standpoint of eventual coverage of more than 3 million square miles

of territory with approximately 130 million inhabitants. The size of this problem is much more formidable here than is the case, for example, in England, where the area is small and the population is concentrated. There, the Government subsidises the television experiments and the broadcasting of television programmes, but the owner of a home-receiving set must pay an annual licence fee to the Government. In the United States, as you know, home radio reception is free and we hope, through the development of private enterprise, also to maintain television reception free.

"Technically, the art of television needs still further improvement in transmission as well as reception. As these improvements are made, the cost should decrease and thereby reduce the magnitude of the financial problems of establishing a nation-wide television service. In addition to these practical considerations, there is the further problem of developing studio and programme technique to meet the requirements of such a revolutionary form of public entertainment, information and education. The programme service will be costly, and its support will devolve primarily upon the sponsors of television programmes, as is the case today with the sponsors of sound broadcasting.

"Before sponsors can be interested in supporting television programmes, it is necessary to provide a seeing as well as a hearing audience; and here we have the age-old question of what comes first, the chicken or the egg. Nevertheless, it is my firm conviction that one day we shall have both the chicken and the egg, and that television ultimately will be established in the United States by private enterprise on a practical basis of free service to the home. The potentialities of television are such as will bring new meaning to the service and business of radio.

"Developments here and abroad have demonstrated the fact that R.C.A. is in the forefront of technical development in this new and promising field. Recently the authorities responsible for television in England adopted the Marconi-E.M.I. system of television in preference to the other systems which they tested. The system thus adopted as the English standard, is based on R.C.A. inventions.

"In our own country, the Columbia Broadcasting System has just announced its plans to enter the field of experimental high-definition television. That company has placed with us, this week, an order for the manufacture of a modern R.C.A. television transmitter to be installed on the Chrysler Building in New York City."

#### A New Departure in Circuit Diagrams

Constructors will notice that in the S.W. section of this issue we have taken the bold step of modifying the method of showing valve connections in our theoretical circuits. The time is coming when all valves will have a standard 8-pin base as indicated by the introduction of International valves by two of our leading makers.

This will mean but one type of valve holder in every receiver and these have been shown in our circuit diagrams in such a manner that the constructor will know to which pins the electrodes are connected without having to refer to valve makers' guides.

# TELEVISION IN CORONATION WEEK

## COMPLETE DETAILS OF ARRANGEMENTS AND PROGRAMMES

THE outstanding television event in Coronation week will, of course, be the televising of the Coronation Procession at Apsley Gate, Hyde Park Corner, on the return journey from Westminster Abbey. The broadcast, which is expected to last one hour, will open at 2 p.m. with views of the Park and crowd scenes between Stanhope Gate and Hyde Park Corner. Telephoto lenses will pick out the head of the procession a quarter-of-an-hour later as it approaches down the East Carriage Drive, and from then until the last horsemen have passed through Wellington Arch to Constitution Hill the whole of the two-mile procession will be shown on the television screen. A descriptive commentary will be given by Frederick H. Grisewood, who will be stationed at a microphone beside the cameras at Apsley Gate.

### How the Procession will be Televised

Three Emitron cameras will be used. Two will be mounted on a special platform at Apsley Gate and will be fitted with telephoto lenses for obtaining distant and mid-shots of the procession and the crowds to the North and South of the Gate. A third camera, installed on the pavement to the North of the Gate, will give close-range views of the Royal Coach and other important parts of the procession passing through the Gate.

The cameras will be connected by some fifty yards of cable to the new mobile television unit behind the park-keeper's lodge, when the sound and vision signals will be conveyed by cable to Broadcasting House and Alexandra Palace.

The mobile television unit comprises three vans; one contains the control apparatus and scanning equipment, one the power plant, and the third an ultra-short wave radio-link transmitter of 1 kilowatt power, which on May 12 will be used as a stand-by for conveying signals to the Television Station.

It is necessary to provide for control room apparatus at the scene of the television broadcast, and, to enable this somewhat ambitious process to be carried out, the B.B.C.

has purchased from the Marconi-E.M.I. Television Company a mobile control room installed in a large motor vehicle.

The apparatus is mounted on two rows of racks along the sides of the vehicle, leaving clear a middle aisle for the engineers operating the equipment. There are six racks each side, each rack 7 ft. 6 ins. high and 19½ ins. wide. The operators are able to see the televised picture on a reproducer fitted into the compartment over the driver's head, and make the necessary adjustments.

In addition, the vehicle is equipped as a small sound control room with all the necessary "faders" and amplifiers to deal with four microphones, which will pick up the voice of a commentator and local sounds associated with the scene being televised.

The mobile control room vehicle will be parked on the grass on the west side of Apsley Gate, behind the park-keeper's lodge, and three multiple cables for the cameras will run from the vehicle to the top of the gate across which they will pass, concealed, to drop down behind a pillar at the point where the cameras are mounted. These cables are about 1½ ins. in diameter and contain twenty-seven insulated conductors, two of which are of a special low-capacity type to carry the high-frequency impulses required for the Emitron cameras.

The stand-by transmitter vehicle will be parked alongside the other, and will radiate the vision signal from a small highly directional aerial mounted on two low wooden masts close to the scene of operation. The signals emitted from the transmitter will be intercepted at Alexandra Palace by means of a small aerial mounted at the top of the main transmitting mast and conveyed thence to a receiver below through a shielded high-frequency feeder. The output of the receiver will be used to modulate the main transmitter in the ordinary manner, and the signals will then be re-broadcast on the usual vision frequency.

### The Week's Programmes

Outstanding among the studio programmes in Coronation Week will be

the appearance of Alicia Markova and Anton Dolin on Tuesday, May 11, with members of their company in a Pas de Quatre and Tchaikowsky's "Blue Bird" suite. Special Coronation editions of "Picture Page" will be presented in the afternoon and evening and it is expected that many of the visitors will have been directly concerned with the Coronation preparations. On the same day, Gerald Cock, Director of Television, will give an illustrated account, both in the afternoon and evening, of the arrangements for televising the Coronation Procession. Films and photographs will be used and, through the co-operation of Scotland Yard, special plans will show how London traffic will be controlled on Coronation Day.

A "Music Hall Cavalcade," which will be the main feature in the evening television programme on Coronation Day, will be presented in a novel manner. An elderly couple, who recall the grand old days of Victorian and Edwardian music hall, will see their reminiscences take form and substance as the favourites of yesterday and to-day reappear on the television screen. The artists will include Albert Whelan, Ada Cerito, Tom Costello, Marie Lloyd, junior, and Ida Barr.

Harry Roy's Band will be televised, with Princess Pearl, in the afternoon programme on May 13. In the evening transmission Clapham and Dwyer will be featured in "Starlight."

On Friday, May 14, Jack Hylton will bring his band to the television studio. The instrumentalists and vocalists number nearly forty—the largest musical combination yet televised.

Television will televise itself on Saturday, May 15, when both afternoon and evening programmes will be devoted to a tour of the London Television Station. The Guide will be Leslie Mitchell, television announcer, and the visitor, George Robey, who will accompany the roving camera to the reception hall, to rehearsal, the sound and vision transmitters, the make-up and dressing rooms, production shop, film projection room, control room and studios.

# FIELD STRENGTH MEASUREMENTS OF THE ALEXANDRA PALACE TRANSMISSIONS

## RESULTS OF A COMPLETE SURVEY OF THE SERVICE AREA

*The information given on this and the two following pages relating to field strength measurements of the Alexandra Palace transmissions is reprinted by kind permission of the B.B.C. from the B.B.C. Annual, 1937. It will provide a valuable guide for the installation of television receivers within the area shown by the maps.*

THE institution of a television service by the British Broadcasting Corporation has created, for the Research Department, the necessity of investigating transmission phenomena peculiar to ultra-short waves.

Field-strength measuring apparatus suitable for use on television wavelengths has been designed and used,

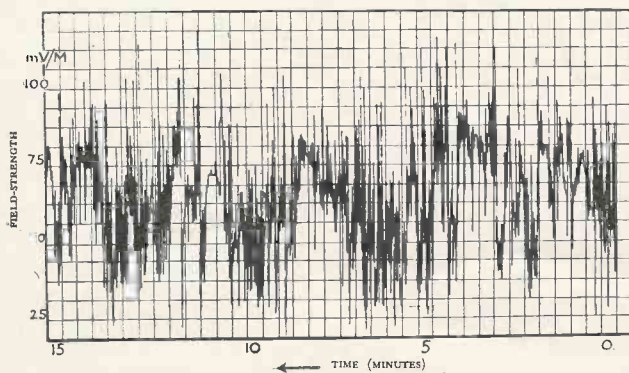

Fig. 1. Variations of field strength due to passing traffic.

during the development period, to investigate signals on 7.75 metres radiated by an aerial on the roof of Broadcasting House. These tests showed the necessity of adopting a special technique for ultra-short wave field-strength measurements, and, at the same time, revealed many interesting phenomena regarding the habits of these waves, particularly in built-up areas. Field-strength contours of the Broadcasting House transmitter were charted, and investigations made into the phenomena associated with the propagation of horizontally polarised transmissions. Measurements on the Alexandra Palace transmitters were commenced immediately the experimental transmissions were available, and a field strength contour chart of this station has now been prepared.

### The Apparatus Employed

This field-strength measuring apparatus is accommodated in a specially constructed van the bodywork of which is practically free from metal parts. For the reception of signals a dipole is used which is mounted

on the roof of the van. By means of a projecting arm inside the van the dipole can be turned to either a vertical or horizontal position, and, when horizontal, can be rotated from inside the van. The direction in which the aerial is pointing is also indicated to the occupants of the van by means of a pointer moving over a scale mounted on the roof. The dipole is collapsible in order to avoid inconvenience when in traffic, among trees, or when passing under low bridges.

The equipment inside the van consists of the field-strength measuring receiver with associated calibrating equipment, a recording millimeter and a subsidiary unit embodying a "Tunograph" tuning indicator which is used to measure the level of interference from motor-car ignition systems. The engine of the van is equipped with ignition interference suppressors as marketed. It is found practicable, when suppressors are fitted, to record field-strengths of less than  $50\mu\text{v/m}$ , with the van in motion without appreciable interference from the ignition system.

### Special Technique Necessary

It became apparent very soon after the start of these investigations that established field-strength measuring technique as developed for the medium wave band would have to be abandoned and other methods adopted. It was found that it was impossible to determine a representative figure for the field-strength in a given area by means of

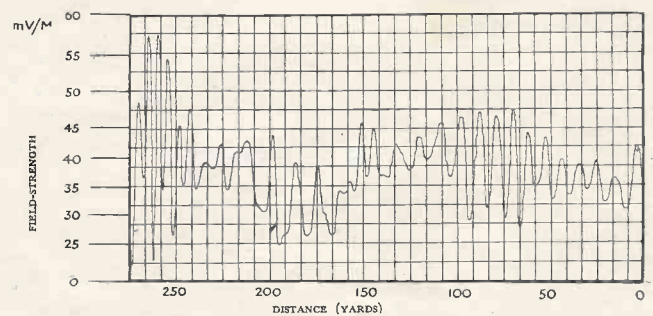

Fig. 2. Standing wave pattern obtained in a relatively unshielded area.

spot measurements in a few representative points. Some idea of the impracticability of such a scheme is



conveyed by the illustrations of Figs. 1 and 2. The first figure shows the variation in received field-strength from the Broadcasting House transmitter with the measuring van stationary on Balham Hill. (The variations are entirely due to reflection and absorption effects of passing traffic. The record of Fig. 2 is typical of the standing wave pattern existing in a relatively un-screened area.

In order to obtain sufficient information to plot field-strength contours it has been found necessary to take continuous field-strength records. Streets carrying much traffic must be avoided and measurements made

in quiet by-roads. The normal procedure is to take a continuous record of the field-strength variations throughout a district, and then to determine the average value from the record. A sufficient number of such records having been obtained, a field-strength contour map can be prepared. It must be realised, however, that such a map can only represent the average signal in a region, and that individual measurements may reveal divergencies as great as  $\pm 10$  db. in certain cases.

Field-strength contour maps of the Alexandra Palace sound transmitter are shown in Figs. 3 and 4, Fig. 3 giving the field at 2.5 m. above the ground, while Fig. 4

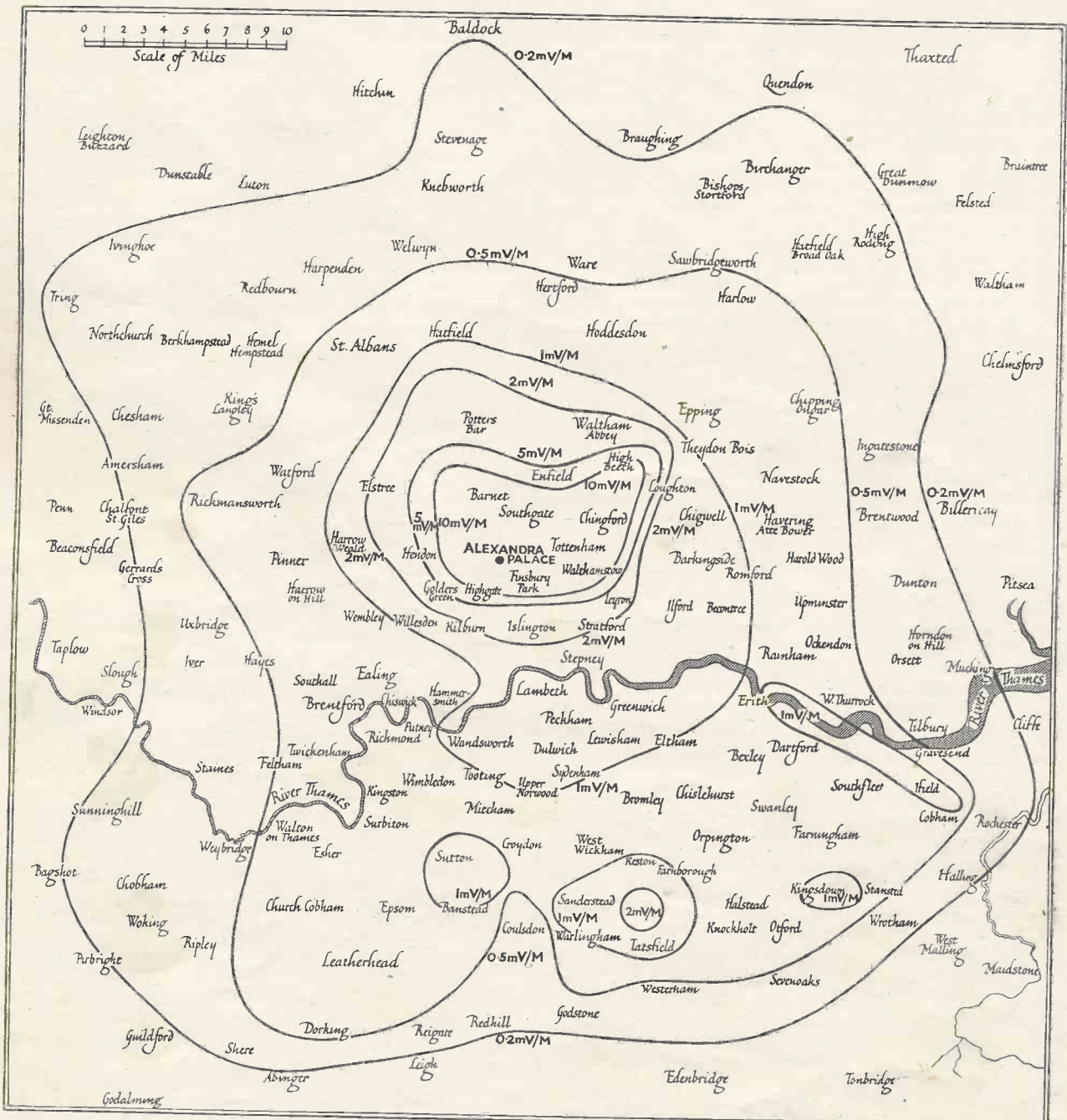

Fig. 3. Alexandra Palace Transmitter field strength measurements;  $f = 41.5$  Mc/s. Power = 3 kW. Field-strength contours at a height of 2.5 metres above the ground.

MAY, 1937

gives the field at roof-level, i.e., where a television aerial would normally be placed. The Alexandra Palace vision transmitter gives a field whose average value is about  $1\frac{1}{2}$  db. below that of the sound transmitter. The standing wave systems of the two transmitters are, however, independent, and individual measurements have revealed field-strength ratios up to  $\pm 6$  db.

On the medium wave band it is quite satisfactory to make measurements at street-level, and to use the results to determine the signal received using elevated aerials. On ultra-short wavelengths this is no longer the case. Measurements using elevated aerials indi-

cate that the received field-strength increases by about 0.3 db. for every foot increase in height above the ground up to a height of about 40 to 50 ft. For greater heights the relative increase in signal strength is reduced. In order, therefore, to determine the probable received signal strength in any position from the Alexandra Palace transmissions, the ground field-strength as indicated by the contours of Fig. 3 should be increased by a quantity appropriate to the height of the receiving aerial. This has been done in the preparation of Fig. 4, assuming a roof height of 10 to 15 metres.

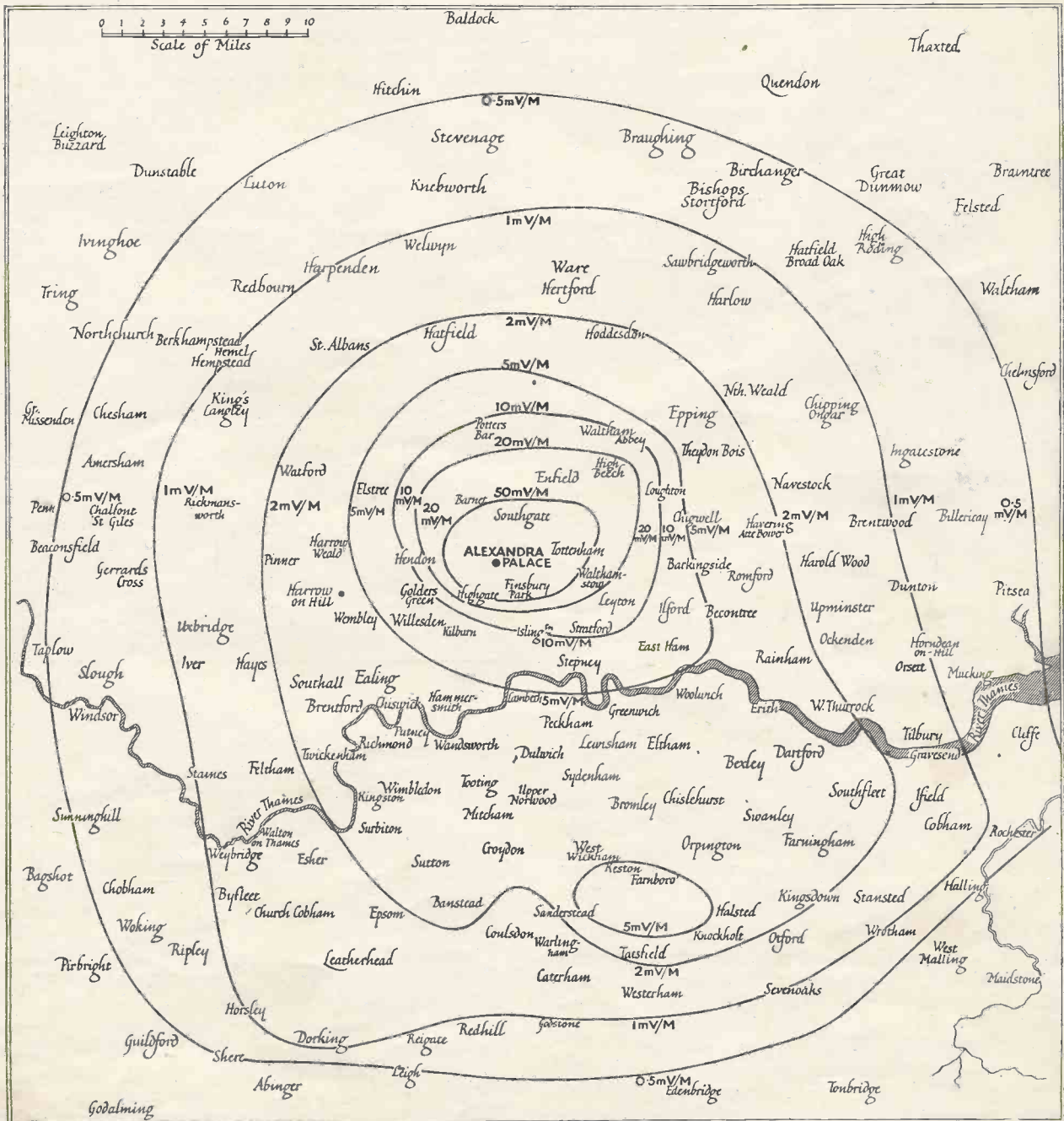
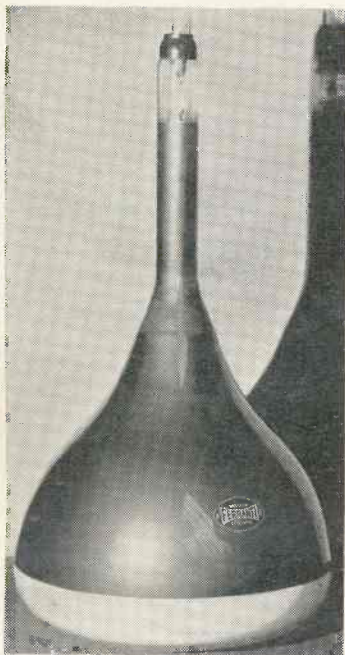

Fig. 4. Alexandra Palace Transmitter field strength measurements;  $f. = 41.5$  Mc/s. Power = 3 kW. Estimated contours at roof level (i.e., 10 to 15 metres above ground).

# MAGNETIC SCANNING DEFECTS— AND THEIR CAUSES

*Magnetic scanning has received very much more attention in America than it has in this country where electrostatic methods are almost general. Increasing interest is however becoming evident here and in view of this the information contained in this article which is derived from a paper read before The Radio Club of America by I. G. Maloff will be of special interest.*

**T**HERE are four important considerations for any deflecting system, the requirements being: deflection sensitivity, freedom from defocusing of the luminous spot, freedom from distortion of the pattern and sufficiently high overall frequency response.



*The Ferranti tube is one of the few in this country to employ magnetic scanning.*

Two main forms of defects of the scanning pattern present themselves on the screens of cathode-ray tubes. The first is defocusing of the luminous spot, and the second is the distortion of the scanning pattern. By defocusing of the luminous spot is meant the change of the size of the spot when deflected. By distortion of the scanning pattern is meant the deviation of the pattern from its normal rectangular shape. The degree to which the above defects may be present in a particular magnetic deflecting system is determined primarily by the shapes and types of the deflecting fields.

There are two more common defects caused more or less by the deflecting circuit as a whole. They are: non-uniform distribution of the scanning pattern or non-linearity of the sweep, and the cross-modulation between the vertical and horizontal circuits. For the first of these, the wave shape of the magnetic driving circuit and the frequency response of the yoke are responsible. For the second, either the coupling between corresponding driving circuits or the coupling between the fields of the yoke may be the cause.

Both electrostatic and magnetic deflecting systems are subject to the defects enumerated above, and the work of improving both types has been in progress for several years. The early high definition systems in

America employed magnetic deflection both ways; early systems in Europe showed preference for electrostatic both ways. At present most of the systems used in America utilise either a combination of electrostatic and magnetic deflection or the all-magnetic systems. (Fig. 1.)

The combined system provides only a partial solution, however. The main source of trouble in such a combination is the defocusing of the spot by the electrostatic field. A certain small amount of similar defocusing shows itself even in the best modern magnetic deflecting systems. The old magnetic systems had an exceedingly large amount of defocusing. All-magnetic systems seem best from the viewpoint of defocusing difficulties, and most of what follows refers to the all-magnetic deflecting system.

## Defocusing of the Luminous Spot

Magnetic defocusing is caused by two factors: first, for a given non-uniform magnetic field it is a function of the diameter of the beam while it is under the action of the field, and second, for a given cathode-ray tube it is a function of the non-uniformity of the field in the direction of deflection.

The mechanism of defocusing will be better understood by considering Fig. 2. Consider an electron beam of a circular cross-section with electrons moving parallel to each other. Such a beam before it is deflected will produce a luminous spot B on the screen. This spot will be of a circular shape. Now let us deflect the

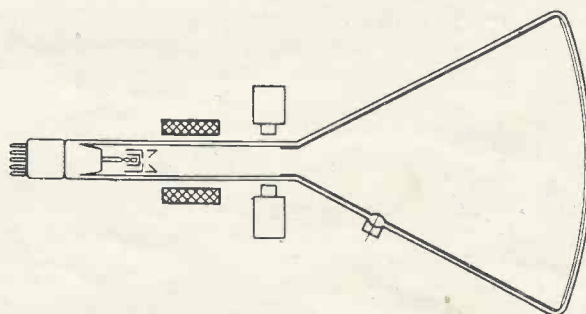

*Fig. 1.—Magnetically-focused tube shown diagrammatically.*

beam to one side of the screen by means of a magnetic field produced by electromagnets C and C<sub>1</sub>. Following the right-handed screw rule the beam will be so deflected that the spot will shift to D. The magnetic field produced by the two coaxial bar magnets will be of a barrel shape form and will be the densest in the middle. The cylindrical electron beam had initial direction towards the centre of this field, but when deflected

## SCANNING-PATTERN DISTORTION

it will miss the axis. The side of the beam which is closest to the axis will be deflected more. The side directly opposite will be deflected less. The spot will be compressed along the direction of deflection. It can be shown mathematically that any non-uniform magnetic field possesses a certain curvature, which is a function of the non-uniformity.

Fig. 3 shows a beam of cylindrical shape being deflected away from the centre of a barrel shape field.

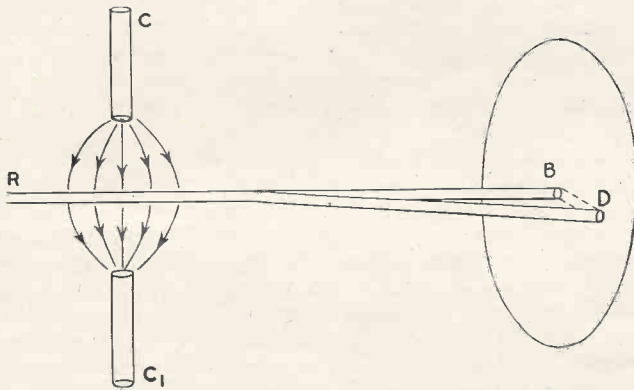

Fig. 2.—The effects causing defocusing.

Away from the plane of symmetry of the field, the curvature of the field results in a component of the field parallel to the plane of symmetry. These components, however, have opposite directions on the opposite sides of the plane of symmetry. In the case shown the upper and the lower parts of the beam will be stretched away from the plane of symmetry in opposite directions, and this will change the shape of the spot from a circle to that of an ellipse with a major axis perpendicular to the direction of deflection.

Therefore we may conclude that the non-uniformity of the field and the curvature of it both act to change the luminous spot into an ellipse with its major axis perpendicular to the direction of deflection. But this will hold only if the direction of deflection is away from the region of the field where it is most concentrated.

When a cylindrical beam is pulled into a field towards the region where it is more concentrated, the beam is stretched into an ellipse with its major axis parallel to the direction of deflection. We may look at the effects of non-uniform fields from another angle. A non-uniform field affects a cylindrical beam as a divergent cylindrical lens.

For deflection towards weaker regions of the field, the axis of this lens is parallel to the plane in which the direction of the deflection lies. For deflection toward stronger regions of the field, the axis is perpen-

dicular to this plane, and the larger the beam diameter the larger the effect of a given field.

So far we have considered only the cylindrical beams. In practice we always have converging beams, which are either focused, or underfocused, or overfocused. It can be shown by reasoning similar to that just given that if a field stretches an overfocused beam in a particular direction, a readjusting of the focusing field to give an underfocused condition will stretch the spot in a direction perpendicular to the former.

### Distortion of the Scanning Pattern

By distortion of the scanning pattern is meant the deviation of the pattern from its normal rectangular shape. When all the four corners are pulled away farther than they should be, we get a pincushion pattern and when these corners are not pulled far enough we get a barrel pattern.

Distortion as well as defocusing is caused by the non-uniformity and the curvature of deflecting fields. A combination of two magnetic deflecting fields each of which is of barrel shape distribution causes a pincushion pattern. A combination of two pincushion fields produces a barrel shape pattern.

The reason for these effects can be better understood by considering Fig. 4. Fig. 4a shows how the components of two pincushion fields add together and give comparatively small resultant for corner deflection and

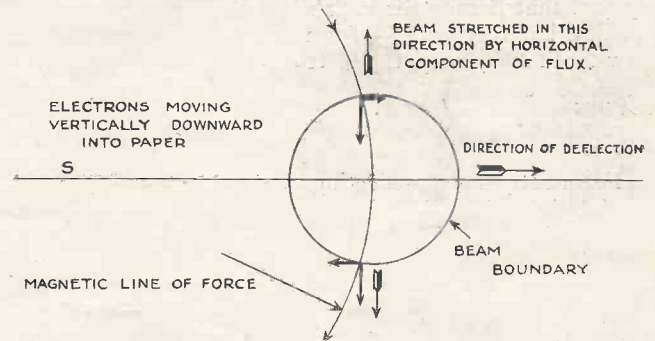
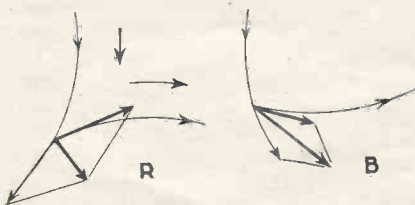

Fig. 3.—Deflection of cylindrical beam from centre of barrel shape field.

a barrel shape pattern. Similarly, the components of two barrel shape fields add together as shown on Fig. 4b and give a pin-cushion pattern.

### Overall Frequency Response

To reproduce a saw-tooth wave shape the magnetic deflecting yoke should be capable of responding to many harmonics of the saw tooth frequency. Other ways of obtaining the same result have been suggested, but so far have not proved advantageous. For an infinite ratio of picture to return sweep the co-efficients of successive harmonics are inversely proportional to the order of the harmonic. If the amplitude of the fundamental is 1, the second harmonic comes out as a half, and the third harmonic as a third, and the tenth as a tenth. Therefore the tenth harmonic is of an amplitude equal to ten per cent. of the fundamental.



Figs. 4a and 4b.—Diagrams explaining pincushion effect.

## CROSS MODULATION

This is rather high, but it will be interesting to take a simple example. 340 lines and thirty frames makes 10,200 lines or sweeps or cycles of the fundamental per second. This means that the tenth harmonic has a frequency of 102 kilocycles and contributes ten per cent. to the wave. Fortunately we synchronise the picture every frame and every line. For positive synchronising we have to take about 10 per cent. of the time. This permits us to have, say, a ten-to-one ratio. Now for a nine-to-one ratio (which is easier to compute than the 10:1 case) of the saw tooth wave, if the amplitude of the fundamental is 1, the amplitude of the second harmonic comes out as .495, the third .300, the fourth .187, the fifth .131, and the tenth is negligible. So we may add to the requirements of a deflecting

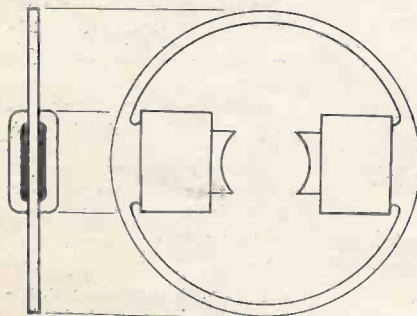

Fig. 5.—Diagram of magnetic deflecting yoke.

system that it must be capable of responding to a frequency band extending from the fundamental of the saw-tooth frequency to its tenth harmonic.

### Cross Modulation

Frequently in a deflecting system, a serious cross modulation takes place between the horizontal and vertical circuits. Usually it is the horizontal impulse which finds its way into the vertical deflecting circuit and produces wavy zigzag scanning lines instead of straight lines. It may be caused by coupling of some sort between the driving circuits. (This kind of cross modulation is usually eliminated by electrically isolating and

shielding the respective circuits. Often, however, it takes place because of either electrostatic or magnetic coupling between the coils of the deflecting yoke.

The type and degree of coupling is usually definitely connected, with electric, magnetic, and physical arrangements peculiar to this particular type. It cannot be treated therefore in general, and has to be studied individually with every particular type of deflecting system. As a rule, however, the cross modulation can be eliminated by so arranging the coils on the yoke that the undesired induced voltages and currents "buck" each other out. Sometimes it necessitates connecting horizontal coils in parallel and vertical in series. In other cases, both should be connected in parallel.

### Irregular Defects

In our discussion of defects of the scanning pattern, we have considered so far only the perfectly symmetrical yoke and a centrally located electron beam. If, however, for any reason, either the beam is not centrally located with respect to the yoke, or the magnetic return legs of the yoke are not symmetrical, or the coils are not symmetrically located, irregular defects of the scanning pattern result. If the deflecting field is sufficiently uniform, the position of the beam with respect to the yoke is not as critical as in the case of a non-uniform field. Any non-symmetry in the yoke, however, ruins the uniformity of the field and immediately shows itself by producing defocusing in a part of the picture, stretching a corner or a side of the pattern and usually producing serious cross modulation. The symptoms of the irregular defects are such that they are easily located and eliminated by tracing defective coils and by checking the geometry of the yoke and the cathode-ray tube.

In conclusion, let us consider a deflecting yoke of the type shown in Fig. 5. Two such yokes suitably spaced give a very good pattern for a 340-line 30 interlaced frame picture. It is balanced to give a very uniform field along the directions of deflection. Along the beam it naturally gives a wall of flux, so to speak, and a wall of uniform height.

### Book Review

*The Low Voltage Cathode-ray Tube and its Applications*, by G. Parr, Radio Division, The Edison Swan Co. (Chapman & Hall, 10s. 6d.). 156 pp. plus bibliography 76 figs.

*Contents*: Construction and Operation, Focusing, Lissajous' Figures, Linear Time Bases, other Time Bases. Applications to Radio and Industrial Engineering, Television.

The author of this book is well-known to readers of TELEVISION AND SHORT-WAVE WORLD through his articles on the cathode-ray tube, and this book will be welcomed as giving a comprehensive outline of the uses to which the tube can be put. A note-

worthy point is the number of practical circuit diagrams which would enable the reader to adapt the tube to any particular research desired.

In the chapter on television a description is given of the thyatron push-pull time base and references are made to other types, showing how they can be adapted to television requirements. From a writer as lucid as Mr. Parr usually is we should have expected a better description of the synchronising pulse and the D.C. component, but as television is only treated as one of the applications of the tube, no doubt it was difficult to decide what to compress into the space allocated.

Any brevity in the descriptive part

of the book is more than made up for in the bibliography, which is one of the most complete in any book that we have seen for some time.

The author says "no attempt has been made to discriminate between various papers" and wisely, as not everyone has access to a scientific library, but is usually able to refer to one or two technical papers. The references given should enable any user of cathode-ray tubes to find some article bearing on the application in which he is interested.

The book is one which can be confidently recommended to all users of cathode-ray tubes and we hope that it will meet with the response that it deserves.

# BAIRD TELEVISION LTD.

## WORLD PIONEERS & MANUFACTURERS OF ALL TYPES OF TELEVISION EQUIPMENT

### BAIRD TELEVISION RECEIVERS

The Baird Receiver, Model T.5, is the finest set offered to the public. Although costing only 55 guineas it provides a brilliant black and white picture larger than that obtainable on any make of receiver now marketed. Among the factors contributing to the set's performance, are simple operation, wide angle of vision, high fidelity sound and excellent picture detail.

Free installation and one year's service.

Remember, Baird Receivers mirror the world! So place your order now.

PRICE 55 GNS.

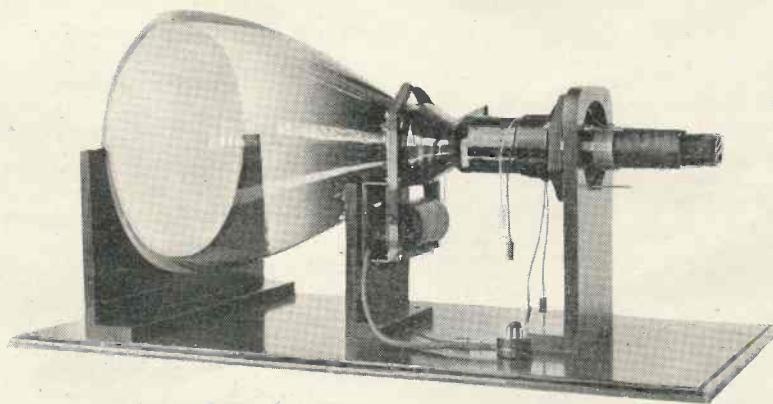

"CATHOVISOR" CATHODE RAY TUBE Type 15 WMI Complete with Electromagnetic Scanning and Focusing Equipment.

### BAIRD MULTIPLIER P.E. CELLS

Baird Multiplier Photo Electric Cells are made in two main types. The first has a small cathode of 15 sq. cms. for use with a concentrated light beam, while the second has a large cathode of 250 sq. cms. for diffuse light.

The Baird Multiplier has a chain of electron permeable grid stages and current gain factors of the order of 100,000 can be obtained. Cathode sensitivity is approximately 40 micro-amperes per lumen and the good spectral response enables the cells to be used for infra red detection and infra red signal amplification. Details on application.

## BAIRD CATHODE RAY TUBES

### TECHNICAL DATA

TYPE 15 WMI.	
Heater volts ... ..	1.8 volts.
Heater amps ... ..	2.4 amps.
Peak to peak volts, between black and highlights ... ..	30 volts.
Maximum electromagnetic sensitivity	2 mm/AT.
Modulator/earth capacity ... ..	2 $\mu$ F (approx.).
Modulation sensitivity (slope) ... ..	6 $\mu$ A/V.
Anode volts ... ..	6,500 volts.
Maximum input power to the screen	3.5 milliwatts/sq.cm
Maximum anode current for high-lights still in good focus ... ..	100 $\mu$ A.
Screen colour	Black and white.

### GENERAL

The Baird Cathode Ray Tube, type 15 WMI, has a hard glass bulb whose screen diameter is 38 cms., total length 74 cms., and neck diameter of 4.45 cms. Apart from manufacturing processes, stringent tests are made for electrical emission, tube characteristics, filament rating and screen quality, and following normal picture reconstitution under service conditions, the completed cathode ray tube is subjected to a very high external pressure test.

All "Cathovisor" Cathode Ray Tubes are completely electromagnetic in operation, a feature of outstanding advantage. Furthermore, not only is the electrode system extremely simple and robust, but due to the special form of cathode employed, a high intensity cathode ray beam is produced which results in a very brilliant picture.

The ideal tube for really large television pictures—12 in. by 9 in.—without distortion.

LIST PRICE, 15 GNS.

Head Office:  
**GREENER HOUSE, 66 HAYMARKET,  
LONDON, S.W.1.**

'Phone: Whitehall 5454

Laboratories:  
**CRYSTAL PALACE, ANERLEY ROAD,  
LONDON, S.E.19.**

Phone: Sydenham 6030

# Pioneers of CATHODE RAY DEVELOPMENT



The range of Cossor Cathode Ray Tubes is the most comprehensive available to-day and is the direct result of Cossor research having kept continually abreast of Cathode Ray development since 1902.

Pioneers, too, in the Television field, Cossor were the first to successfully apply the Cathode Ray Tube to this problem. Continual research has resulted in an incomparable range of Television Reception tubes which are recognised as unparalleled for their qualities of focus and brilliance.

...applications for it yet been  
and.  
It was not until about thirty years later that the cathode-ray tube came to be regarded as an every-day instrument in the laboratory, although as long ago as 1902 Cossors, the valve manufacturers, were producing their first examples.

Full data is contained in leaflet No. L.213, a copy of which will be sent on request to "Instrument Dept.," A. C. Cossor Ltd., Highbury Grove, London, N.5.

"Wireless World" Editorial 2.4.37.

# COSSOR

CATHODE RAY TUBES

A. C. COSSOR LTD., Highbury Grove, London, N.5

# THE FIRST ACORN VALVE RECEIVER FOR VISION SIGNALS

*We believe this to be the first published description of a vision signal receiver employing Acorn valves. It is presented as a matter of interest and it is not claimed that it is superior to the more orthodox types, although the use of Acorn valves offers certain advantages.*

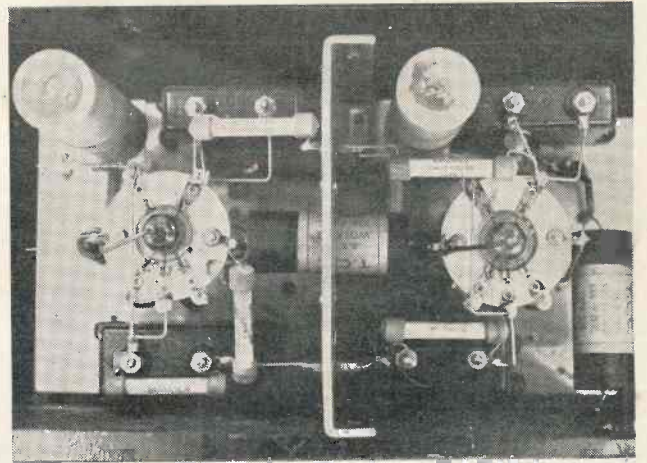

*The two L.F. valves in their compartment.*

THE Acorn valve, first developed in America and now also made in this country, offers some distinct advantages for ultra-short wave reception and particularly for television. Its most important feature is the small interelectrode capacities, while its small physical size makes it possible to build circuits round it with less than the average stray capacity and therefore of higher efficiency.

The first point which has to be decided when approaching the design of an ultra-short wave receiver is how much and what sort of H.F. amplification should be used. (There are three general classes of design:—

- a. Carrier frequency amplification right through to the cathode-ray tube.
- b. Carrier frequency amplification followed by a detector and modulation frequency amplifier.
- c. Superheterodyne.

out of consideration for the constructor. (b) Has the advantage that the stages can be roughly divided as between H.F. and modulation frequency amplification and increased stability thereby secured. (c) Has the usual advantage of fixed tuning for the I.F. stages (a small advantage, when, as in television, the receiver will in any case be used on one wavelength only) but there is the quite serious difficulty of band-passing properly on account of the low ratio of the I.F. to modulation frequency. Even with, say, 20 metres (15 megacycles) the ratio is  $7\frac{1}{2}$  to 1 compared with an average of 100 to 1 for medium wavelength sound broadcasting.

It was thought that the method of (b) might be most worth experimenting with.

Before deciding on the number and arrangement of valves one must make a few preliminary calculations as to

this is determined by the expression  $gZ$ , where  $g$  is the mutual conductance of the valve (2 milliamps. per volt) and  $Z$  the anode load impedance. The impedance  $Z$  depends on the inductance, capacity and resistance of the tuned circuit (it is further assumed that straightforward tuned-anode coupling will be employed) and is given by  $L/CR$ , where  $L$  and  $C$  are together tuned to the carrier frequency concerned—in our case 45 megacycles.

Obviously the greater  $L$  and the less  $C$  the more the value of  $Z$  and hence the amplification. The limiting factor is the capacity  $C$  which is made up of the anode-cathode capacity of its associated valve, together with wiring, stray capacities and the input capacity of the succeeding stage. Since, as mentioned, Acorn valves have much lower self-capacities than other valves (the anode-cathode capacity is less than  $1\mu\text{mfd.}$ ) it is possible to get a greater value for  $Z$  than would otherwise be obtainable. The ideal method is to have no tuning condenser but to adjust the value of the inductance until it resonates with the inherent capacities referred to at the correct frequency. This is, however, a clumsy way of tuning, and in practice one must have a small tuning capacity, though, of course, the smaller the better. The Bulgin S.W.31 short-wave tuning coil is quite a convenient size to choose and has a nominal inductance of  $.63\ \mu\text{H.}$  When tuned to 45 megacycles the value of  $Z$  is approximately 6,000 ohms, assuming the H.F. resistance of the coil to be 5 ohms. This gives a stage gain of 12—quite a useful figure.

Considering the matter of "low" or modulation frequency amplification, the problem here is to keep the

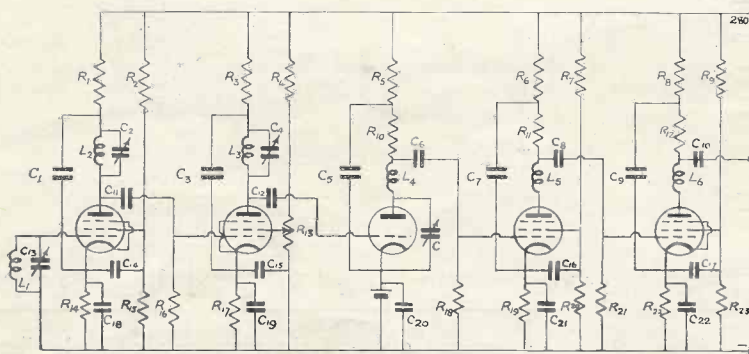

*The circuit of the Acorn valve receiver which is described in detail in the text.*

Of these types of circuit, (a) is favoured by some manufacturers, but as five or more stages are needed it would be exceedingly difficult for an amateur constructor without proper facilities to gang and stabilise such a receiver. This therefore can be ruled

the stage gain obtainable with Acorn valves. Assuming that of the two types available the pentode will be used for amplifying purposes on account of its high input impedance, and considering first the question of carrier frequency amplifica-



## POINTS IN ACORN VALVE RECEIVER DESIGN

gain constant between 25 and two million cycles. (The best method of coupling is that discussed by J. Beardsall in the Feb., 1936, issue of this Journal where an inductance is virtually connected between the anode

LCR<sup>2</sup>, where R is the anode resistance. If the latter is 9,000 ohms L evaluates to 324μH. The precise value used is not very critical and it will be found that an Eddystone short-wave choke (Cat. No. 1010) with two of its four sections short-circuited gives an inductance around 400μH which would answer the purpose quite well. It is quite an easy matter to scrape the insulation from the wire joining the middle two sections and connect this point to one end.

From the foregoing considerations two stages of H.F. amplification and two L.F. will give a theoretical overall gain (excluding any in the aerial circuit or detector stage) of approximately 50,000, which is sufficient for most receiving situations within the service area of the London Television Station at Alexandra Palace.

The modulation frequency amplifier should have a good uniform response and low phase angle down to 25 cycles per second and to this end various decoupling condensers have been made suitably large—e.g., the screen grids are each returned to cathode through 30 μfds., the anode decoupling condensers are 8 μfds. each, and the bias decoupling condensers 500 μfds.

The decoupling of the H.F.

ers of .0003 μfd. have a reactance suitably low for use as anode, screen and grid bias decoupling, and anode coupling to the following stage.

The practice of returning decoupling condensers to cathode has been followed throughout.

(The decoupling resistances are calculated for a H.T. voltage of 300, but anywhere between 250 and 300 volts should be satisfactory, though it should not be allowed to exceed 300 on any account, unless screen grid decoupling condensers having a higher working voltage than 100 of those specified are used. In this connection if the H.T. is derived from a rectifier a thermal delay switch should be incorporated so that the valve cathodes are heated before any volts reach the anodes.)

The detector stage is one which must receive careful consideration, the chief claimants being the diode and anode-bend methods. The former has the advantage of a good amplitude characteristic, but it is hard to combine with it a good frequency characteristic unless the load resistance is so low as to reduce appreciably the stage gain of the previous H.F. valve. If, however, the load is transferred to the anode circuit we can get a good frequency characteristic without loading the H.F. valve,

### Components for ACORN VALVE RECEIVER

- BATTERY, GRID-BIAS.**  
1—Type 4½ volt.
- CHOKES, SHORT-WAVE.**  
1—Type HF14 (Bulgin);  
2—Type 1010 (Eddystone).
- COILS.**  
3—Type SW31 (Bulgin).
- CONDENSERS, FIXED.**  
2—500-mfd. type 502 (T.C.C.).  
2—30-mfd. type 541 "  
2—5-mfd. type 250 "  
9—.0003-mfd. type M "  
1—15-mfd. type 561 "
- CONDENSERS, VARIABLE.**  
3—Type SW54 (Bulgin).  
1—Type SW52 "
- RESISTANCES.**  
4—25,000-ohms 1-watt (Dubilier).  
6—100,000-ohms 1-watt "  
3—50,000-ohms 1-watt "  
2—250,000-ohms 1-watt "  
2—1,000-ohms 1-watt "  
2—9,000-ohms 1-watt "  
1—5,000-ohms 1-watt "  
1—Variable potentiometer 50,000-ohms (Dubilier).
- VALVES.**  
4—Acorn type 954 (R.C.A.). } or British  
1—Acorn type 955 } equivalents  
5—Acorn valve-holders (Claude Lyons).  
6—Insulating pillars, Cat. 1028 (Eddystone).  
6—Insulating pillars, Cat. 1029  
2—Peak electrolytic condenser holders (Bryce).

of a resistance-coupled stage and the grid of the succeeding valve. If a total output and input capacity (with wiring) of a stage is each assumed to be, say, 4 μfds., then it can be shown that with a suitable inductance we can keep the gain level to within 2 per cent. with an anode resistance of 9,000 ohms. This would make the stage gain 18. One could increase the anode resistance and coupling inductance and improve the stage gain, but the limiting factor is the phase-angle, which is already quite large—32 per cent.—at 2 megacycles, and although a much greater amplitude drop could be tolerated, the larger phase angle would give noticeable distortion.

Since the average cathode-ray tube requires an input of approximately 10 volts for full modulation, we have to be sure that this value can be provided without overloading the acorn output valve. The valve is not made to handle any very large voltage swing, but with a stage gain of 18 the grid input necessary would be under .6 volt and should just about fall within the capabilities of the valve.

The coupling inductance necessary is calculated from the expression

R. 1—25,000 ohms Dubilier 1 watt.	C. 3—.0003 mfd., type "M."
R. 2—100,000 " " "	C. 4—14.5 mmfds. (Bulgin S.W.54).
R. 3—25,000 " " "	C. 5—6.0 mfd.
R. 4—100,000 " " "	C. 6—5 mfd., T.C.C.
R. 5—250,000 " " "	C. 7—8.0 mfd. Electrolytic.
R. 6—25,000 " " "	C. 8—5 mfd. T.C.C.
R. 7—100,000 " " "	C. 9—8.0 mfd. Electrolytic.
R. 8—25,000 " " "	C.10—5 mfd.
R. 9—100,000 " " "	C.11—.0003 mfd., type "M."
R.10—10,000 " " "	C.12—.0003 mfd., type "M."
R.11—9,000 " " "	C.13—14.5 mmfds. (Bulgin S.W.54)
R.12—9,000 " " "	C.14—.0003 mfd., type "M."
R.13—50,000 " " "	C.15—.0003 mfd., type "M."
R.14—1,000 " " "	C.16—30.0 mfd. Electrolytic.
R.15—50,000 " " "	C.17—30.0 mfd. Electrolytic.
R.16—100,000 " " "	C.18—.0003 mfd., type "M."
R.17—1,000 " " "	C.19—.0003 mfd., type "M."
R.18—250,000 " " "	C.20—.0003 mfd., type "M."
R.19—1,000 " " "	C.21—100.0 mfd. T.C.C. Electrolytic.
R.20—50,000 " " "	C.22—100.0 mfd. T.C.C. Electrolytic.
R.21—50,000 " " "	L.1—Bulgin Coil Type S.W.31.
R.22—1,000 " " "	L.2—Bulgin Coil Type S.W.31.
R.23—50,000 " " "	L.3—Bulgin Coil Type S.W.31.
C. —2.5 mmfds. (Bulgin S.W.52).	L.4—Bulgin Type H.F. 14 Choke.
C. 1—.0003 mfd., type "M."	L.5—Eddystone S.W. H.F. Choke (½ only).
C. 2—14.5 mmfds. (Bulgin S.W.54).	L.6—Eddystone S.W. H.F. Choke (½ only).

stages is largely a question of using condensers of low inductance as this is likely to be the predominating reactance. Advantage of this can sometimes be taken by using a capacity which will resonate with its self-inductance at the carrier frequency. It will be found that the small T.C.C. mica conden-

and the greater amplitude distortion given by the anode-bend detection is not of serious importance.

The design of the anode circuit is not without its problems, one of which is to filter the carrier frequency from the modulation frequencies without loss of the latter at the upper end.

(Continued in 1st col. of next page)

# Scannings and Reflections

## THE CORONATION

VERY complete details of the plans made for televising the Coronation procession are given on another page in this issue. Briefly, the B.B.C. hopes to televise the procession at Apsley Gate, Hyde Park Corner, on the return journey from Westminster Abbey. The broadcast, which will last approximately an hour, will open with crowd scenes and be accompanied by a running commentary. Three cameras will be used. One of these, installed on the plinth of Apsley Gate, will provide overhead views of the advancing procession, while a second camera operated from the pavement immediately to the north of the Gate will provide close-ups as the procession passes through the arch. Another camera facing south will show the end of the procession.

## STUDIO "INTERFERENCE"

On several occasions of late there has appeared to be an unwarranted amount of noise in the studio at Alexandra Palace apparently caused by those responsible for rearrangement. During a recent evening talk

## "THE FIRST ACORN VALVE RECEIVER FOR VISION SIGNALS"

(Continued from preceding page)

The anode load resistance has to be lower than that used in the succeeding stages—5,000 ohms being used. Forming an H.F. filter is a Bulgin ultra-short wave choke (type H.F.14) and, between anode and cathode, a Bulgin 2.5  $\mu$ fd. semi-variable condenser (type S.W.52). Owing to the difficulty of estimating the cathode resistance necessary to give the required grid bias for a valve such as this where the anode current depends upon the applied grid volts it will be safer to insert a small  $4\frac{1}{2}$ -volt grid-bias battery in the cathode lead, tapped to provide the correct bias voltage. The accompanying panel gives the list of components required for this receiver.

The layout and constructional details of the receiver will be dealt with in a following article next month.

there was so much noise that it almost drowned the voice of the speaker at times; in addition to the noise one would associate with the moving of heavy furniture about there was shouting and whistling. And the curious part was that when *the next scene appeared* there was no apparent change in what had gone before.

## WHAT TELEVISION COSTS

The annual report just issued by the B.B.C. shows that in 1936, for two months of television a revenue expenditure of £111,500 had to be met in addition to a net capital expenditure of £116,546, making a total of £228,046. Though expenditure will not continue to proceed at this rate, the figure for two months' service in 1936 clearly shows that a great deal of money will have to be found every year to maintain and develop the service.

## FINDING THE MONEY

There have been many rumours about lately that in order to find the money for television the ordinary listener's licence fee is to be increased to 12s. 6d., in fact, so persistent has the rumour been that many listeners are quite concerned at the prospect of having to pay for something which they do not receive. The improbability of such a happening hardly needs comment, for it would be met with a storm of protest that would be impossible to withstand.

The suggestion of a special licence for television has also been mooted, and though this appears to be the eventual solution of the problem of finding the money to finance the broadcasts, at the present time the income which could be derived from this source would be insignificant. The immediate solution appears to be a claim on that 25 per cent. portion of the licence fee which at present goes to the Exchequer. It will be remembered that the Ullswater Committee recommended that this should be potentially available for the B.B.C. if it was required for further development.

The Government accepted the recommendation that the B.B.C. should be entitled to apply for a further allocation should it be required, but whether they will get it is another matter.

## ON APPRO.

According to one manufacturer of television receivers several cases have occurred of individuals asking for a television receiver to be installed on approval for the sole purpose of entertaining their friends for an evening. The next day they have stated that they did not wish to keep the receiver and have asked for its removal. Considering the work that is involved in installing a television receiver, which includes the erection of a special aerial and testing, this is a bit tall, so the practice has been obviated by making a fixed charge of three guineas to cover expenses should the receiver not be retained.

## TELEVISION IN RUSSIA

A report just issued by the All Union Radio Committee of Russia shows that the total time of television broadcasts in that country during 1936 occupied 480 hours, or 1.7 per cent. of the total broadcasting time. Entertainment accounted for 44.5 per cent., and information, 33.2 per cent.

## NO PRIVATE STATIONS IN FRANCE

The French Minister of P.T.T. has announced that all television experiments shall be made by the Government in collaboration with specialists only. Refusals have been made to Poste Parisien and Toulouse for permission to transmit television, despite the fact that in the former case the necessary apparatus has already been installed. The reason given is that the development of television must proceed upon ordered lines and not in the haphazard fashion which was experienced in the development of sound broadcasting.

M. André Serf, president of the Manufacturers' Union, during an interview with M. Godfrein, engineer representing M. Jardillier, French P.M.G., said that it was of the highest importance for the develop-

## MORE SCANNINGS

ment of television in France, that a single and definite standard for a 2-3 years' period be adopted as soon as possible. Until it is, French industry will be largely handicapped, "particularly in comparison with the British industry, which knows its standard, since about a year ago."

He further stressed the importance of precautions which will prevent the adoption of a standard giving a *monopoly of fact* to any industrial group.

### B.B.C. TO PRODUCE A FILM

The B.B.C. is to produce another film for television and propaganda purposes. This film is to deal with the development of television from its earliest beginnings and, in addition, will provide excerpts from some of the most successful programmes. Production will be done at the Cricklewood studios, and in addition to its use for propaganda purposes it will form the principal item for the morning broadcasts which are contemplated to enable dealers to demonstrate receivers.

### AMERICA IS INTERESTED

Television developments in this country are interesting the radio industry of America. Mr. M. K. Taylor and Dr. N. H. Searsby, both of the Ferranti Radio and Television Research Department, sailed recently in the *Queen Mary* for the purpose of exchanging information with representatives of the industry in that country. They took with them an example of the latest Ferranti television receivers.

### WHERE ARE THE ANNOUNCERS?

Why do those responsible for presentation at A.P. still continue to make announcements of programme matter by means of lettered notices. Even when a verbal announcement is made the announcers are seldom in evidence visually. After all the fuss that was made regarding the selection of the announcers it seems remarkable that so little use is made of them, particularly during the intervals which appear to be so essential in the television programmes.

### AERIAL HEIGHT

The importance of aerial height has often been stressed in these columns, and it will be clear how this is borne out in the field strength maps which

are published on other pages in this issue. It will be seen that at a height of about twenty feet there is an increase in some cases of as much as five times the strength at about six feet above ground.

### KERR MEMORIAL LECTURE

The Kerr Memorial Lecture of the Television Society will be given on Wednesday, May 19th, by Professor J. T. MacGregor-Morris, M.I.E.E., Head of the Electrical Engineering Department, Queen Mary College, and the subject will be "The History and Development of the Cathode-ray Tube." The lecture will commence at 7 p.m., and will be illustrated by experiments and historical exhibits.

It will be given in the Lecture Theatre of the Royal Institution, Albemarle Street, London, W.1, which has been loaned to the Society for this annual lecture.

Cards of invitation may be had on written application to the Honorary General Secretary, J. J. Denton, Esq., 25 Lisburne Road, Hampstead, N.W.3.

### PROGRESS ABROAD

From the information that is given on other pages of this issue it will be evident that very serious attention is now being given to television in other countries, particularly in America and France. In the former country both the National Broadcasting Company and the Columbia Broadcasting System are making elaborate plans and, in addition, there are other lesser but important concerns engaged in development. The Don Lee Broadcasting System, of Los Angeles, California, for example, is putting out a series of transmissions which, although experimental, are worked to a schedule, and the Philco Radio and Television Corporation are also transmitting on the new American standard of 441 lines.

Farnsworth Television Inc. have also been making regular experimental transmissions for a considerable time with 343 lines and this gear has just been altered to conform with the new U.S.A. standard of 441 lines with a power of 4 kilowatts. Radio Pictures Inc. is another concern that is taking an active part in television development and regularly

scheduled experimental broadcasts will be made when the new equipment operating on the new standards is completed.

Very little information regarding German activities has been revealed since the last Berlin radio exhibition, but it is known that the German research engineers are now paying serious attention to electronic methods.

In Italy the Italian Broadcasting Company has set up a research board at their Rome station for the purpose of engaging in television work, but so far as is known no public service is contemplated at present. Several private concerns are also experimenting.

High-definition research is also being conducted in Holland, Sweden and Japan, and in Russia the construction of three high-definition stations has been planned for operation in Leningrad, Moscow and Kiev.

### SWEDISH LOW-DEFINITION TRANSMISSIONS

Low-definition transmissions of vision are being sent out through Motala on a wavelength of 1,389 metres with a power of 100 kilowatts. These transmissions are merely engineer tests and are not accompanied by sound, although the number of lines and type of system is usually given before the vision signals are put on the air. These transmissions are for one hour, from 11.30 a.m. to 12.30 p.m., Monday to Friday.

### FOCUS

Among the many criticisms of the television programmes, that of focus is often brought up. However poorly our receivers may be adjusted we are often aware of the principal artist or objects suddenly becoming much clearer or vice versa. This is due to camera manipulation. Last time we were in the studio we noted that the type of lens used is an F/3 6.5-in. focus. Such a lens, photographers will know, has very little "depth" of focus, that is to say, suppose we focus on an object 3 feet away anything nearer than 2.93 feet or further than 3.08 feet will be out of focus, taking 1/100 inch as the circle of confusion, which in photography is rather a low standard. With such fine limits to work to it is a wonder how anything is even kept in focus at all.

Our Policy  
"The Development of  
Television."

## AND MORE REFLECTIONS

## PROGRAMMES FOR SHORT-WAVE LISTENERS

The three American broadcasting groups are being inundated with letters from European listeners, and not all sending bouquets. While American stations are being well received, the programme matter is not always of the highest order. Arrangements are being made by at least one company to record some of the best items and re-play them over the short-wave stations at more convenient times.

This will mean that short-wave listeners will be able to hear the best of the American programmes without burning the midnight oil.

## BREAKDOWNS

These have been numerous since the decision to use only one system was made. This is not surprising when one considers how relatively little apparatus is at the Palace, and the amount of work which it has to do. Transmissions probably take only 20 per cent. of the total working hours of the gear. What actually is the cause of these breakdowns is not published, but we gather that they are generally due to failure of the supply circuits, H.T. and L.T., rather than the television apparatus proper.

## THE OFFICIAL B.B.C.

## CORONATION COMMENTATOR FOR TELEVISION

Freddie Grisewood, the popular radio announcer at Broadcasting House, has been moved to Alexandra Palace where he will play a big part in television activities. It has been officially announced that he will be the television commentator of the Coronation Procession; he has already made his debut with the Walking Through Fire transmission on April 20th last. Grisewood's style should do a lot to brighten up the presentation of the vision programmes, while as he is generally full of new ideas we should soon be seeing some of the fruits of his imagination.

## SHORT-WAVE FIELD DAYS

The R.S.G.B. National Field Day is, as usual, to take place in June, when the cream of the Society will be operating portable stations no matter what kind of weather may prevail. These field days are very popular amongst amateurs and increasing numbers take part each year. It counteracts the suggestion that the amateur movement is losing interest

in actual experimental work. The use of portable stations does much to train young operators to be of use in time of national emergency and should be given every encouragement.

Field day stations will be on the air from 18.00 G.M.T., June 5, to 18.00 G.M.T., June 6, 1937.

Direction-finding competitions are periodically held by the Golders Green and Hendon Radio Scientific Society and directed by Lieut. Col. H. Ashley Scarlett, D.S.O.

This year on Sunday, May 23, a competition on 80 metres is being held in the St. Albans district. On June 5 another field-day for 5-metre stations is being organised to test apparatus, while on September 12 there is to be a full 5-metre competition which is open to members.

By making the D.F. competition open to all interested amateurs a large number of entrants are always obtained, so the competition becomes of national interest rather than only to the members of the society.

## CORONATION RELAYS

The General Electric Company, in addition to exporting huge quantities of all-wave receivers to be delivered before the Coronation, are completing the installation of a permanent radio relay service in British West Africa. The service will operate through 5,250 loudspeakers from seven centres. Installations at Lagos, Accra, Cape Coast, Sekondi and Freetown, have already been completed, while installations at Koforidus and Kumasi are in course of construction. This equip-

ment is being fitted up in the main villages for educational and entertainment purposes, but at each point as many as 5,000 natives will be able to listen in simultaneously.

## THE TELEVISION SOCIETY

Owing to a typographical error our report on this Society contained on page 211 of the April issue gave readers an incorrect idea as to the membership increase.

Actually there were no less than 394 active members in 1936, as compared with 354 in 1935. During 1936 18 Fellows, 34 Associates and 3 Students were admitted to membership. The Hon. General Secretary of the Television Society is Mr. J. J. Denton, 25 Lisburne Road, Hampstead, N.W.3, from whom all details can be obtained.

## MORE ULTRA-SHORT WAVE TELEPHONE CIRCUITS

The G.P.O. continue to demonstrate the value of ultra-short waves in the commercial world. They have already installed 5-7-metre radio links instead of the usual phone cables over distances up to 110 miles. Additional radio-telephone links are now to be erected for use between Oban and Tobermory on the island of Mull, Tobermory, and the islands of South and North Uist in the Outer Hebrides, and possibly between some of the scattered Scottish islands. Experiments are also being carried out to determine the possibility of using radio instead of cable across the English Channel. The saving in cost by using a radio link instead of cable is very considerable.

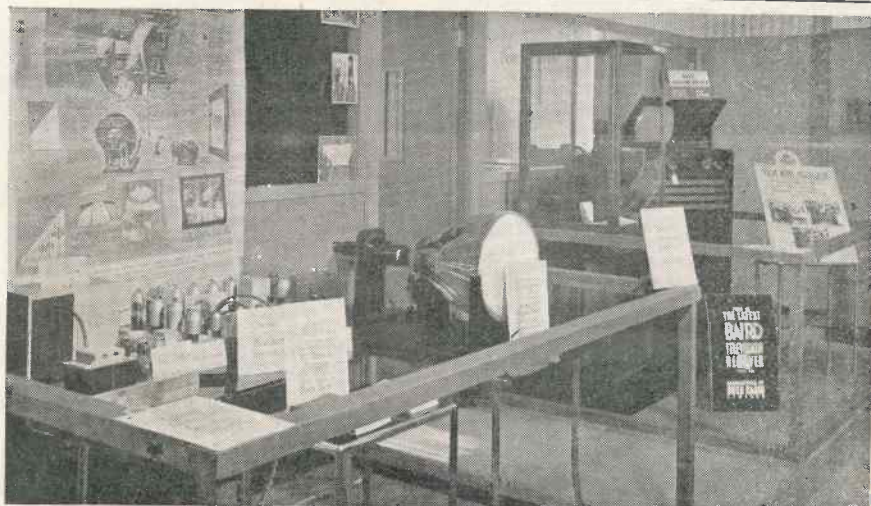

This photograph shows a section of the recent Television Exhibition at Selfridges which was organised in collaboration with Baird Television Ltd.

# TELEVISION AT THE IDEAL HOME EXHIBITION

THE largest scale demonstration of television so far given was staged at the Ideal Home Exhibition at Olympia, and some idea of the success of this demonstration as a side show will be clear when it is stated that the number of visitors averaged three per second or over 10,000 per hour. With two shows a day this meant 20,000 a day (exclusive of visitors during the time when there was no transmission on) or roughly 230,000 for the entire duration of the exhibition.

Long queues, reaching a considerable distance round the hall, formed up at every transmission time, but the arrangements were so excellent that there was very little time wasted in waiting, and every visitor was enabled to obtain a representative view of some part of the programme. Twenty Marconiphone receivers were in use, arranged in a normal way round that section of the hall devoted



The replica of the Alexandra Palace Studio at the Ideal Home Exhibition.

to television, and every visitor had the opportunity of passing before all the receivers should he so desire. Another feature was that the television demonstration section was not in total darkness, as was the case at Radiolympia, and viewers therefore did not require to become accustomed to the change in illumination.

Results were consistently good and the degree of technical perfection that has been attained was the subject of a considerable amount of favourable comment by the public. Despite the fact that there were large numbers of different pieces of apparatus in the building likely to cause interference, this was practically non-existent or

at the most only revealed itself as tiny specks of light, which did not in any way detract from the pictures.

In addition to the demonstration of reception there was a small replica of the Alexandra Palace studio, complete with Emitron camera and floodlights, etc. As this was of necessity small on account of the space available it perhaps did not convey quite the atmosphere of the A.P. studio, but it gave the public some idea of the arrangement and the apparatus used in putting out television transmissions. The organisers are to be congratulated on placing before large numbers of the public an entirely excellent exhibition of television.

## The B.B.C. Annual, 1937

THE B.B.C. Annual, which has just been published, contains 176 pages, profusely illustrated, and covers B.B.C. activities from January 1 to December 31, 1936. It may best be described as the listeners' book of reference, for in addition to a review of the broadcast programmes of the year it presents a wealth of information on such matters as advisory councils, committees of the B.B.C., rules for S.O.S. messages, finance, statistical matters, particulars of arrangements for visits to London and provincial studios, details of weather forecasts, the time signal service, etc. There is also a considerable amount of technical information on radio developments, studio design, transmitter details and a simple explanation of television. In addition the results of the B.B.C.'s survey of field strengths are given which by kind permission of the B.B.C. are reproduced on other pages in this issue.

The price of the Annual is 2s. 6d., or 3s. by post, and it can be obtained from the B.B.C. Publications Department, 35 High Street, Marylebone, London, W.1, or the B.B.C.'s Regional offices.

### "A 4-valve All-wave Super-het"

IN the January, 1937 issue, on pages 39, 40 and 41, we described a 4-valve All-wave Super-het using the B.T.S. all-wave coil unit. The designers of this unit, in order to simplify assembly, have now colour coded the connecting leads.

Constructors should be guided by the following table when connecting up the coil unit. These are the leads and their respective colours. Plain yellow to aerial terminal; plain red to oscillator grid; plain blue to oscillator anode;

READ TELEVISION  
& SHORT-WAVE WORLD  
REGULARLY

yellow and brown to oscillator high tension; plain green to .01-mfd. feed condenser from diode; plain green to top end of volume control; plain black to earth terminal; plain brown to A.V.C. line; and the screened lead to pickup socket.

All the above leads are connected underneath the receiver chassis. The following leads are connected to components on top of the chassis. Yellow and red to front section of ganged condenser; green and black to centre section of ganged condenser; orange to rear of oscillator section of ganged condenser; plain black to rotor plates of ganged condenser.

### "French 5-metre Activities"

BY inference, readers would have assumed that this article, appearing on p. 236 of our April issue, had been especially written by correspondent G5UK, but we owe it both to him and to our readers to explain that we ought to have given full acknowledgment to "Radio Ref" in which much of the information had appeared, the matter having been translated for us by G5UK.



# A NEW MARCONIPHONE RECEIVER

TELEVISION :: ALL-WAVE RADIO  
GRAMOPHONE

*The Marconiphone Model  
703 Mastergram.*

**A** NEW receiver has been produced by the Marconiphone Co., which comprises a television receiver for pictures transmitted with 405 lines 50 frames per second from the Alexandra Palace, together with the sound accompaniment; a four-waveband radio receiver, covering the following wavelength ranges:—16.7-53 metres; 46-140 metres; 185-560 metres; 750-2,200 metres, and an automatic record-changing gramophone enabling up to eight 10-in. or 12-in. records to be played, repeated, or rejected, at will.

The vision equipment comprises the Emiscope tube unit and vision receiver with, of course, time bases and power pack. The vision receiver unit consists of a 6-valve T.R.F. receiver fixed-tuned to 45 megacycles (6.67 metres). This unit amplifies the signal from the aerial some 40,000 times and rectifies it ready for application to the Emiscope cathode-ray tube. (The valve train consists of five Marconi MSP4 valves in series, followed by a Marconi MSP41, the output of which is rectified by a Marconi D42. This output is then split and applied to both the Emiscope tube unit and to the synchronising unit.

The pictures are viewed in a mirror at 45 degrees in the lid of the cabinet, the size of the picture being 10 ins. by 8 ins.

The sound receiver unit is a normal broadcast chassis adapted to deal with the television sound broadcasting on 41.5 megacycles (7.23 metres) as well as the normal long-wave, medium-wave and two short-wave

bands. For the sound accompanying the televised pictures the input to this is taken from the second stage of the vision receiver and it deals with the signal in the normal broadcast manner. The circuit, which is a high-fidelity superhet, consists of a VMP4G H.F. valve, H.F. transformer coupled to the X41 mixer

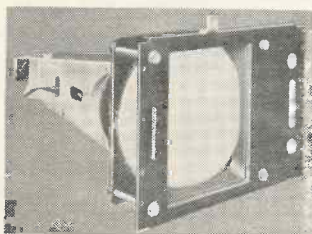

*The Emiscope cathode-ray tube is mounted  
in a special chassis.*

valve. The resultant I.F. signal at 460 kc. is applied to the I.F. stage and passed on via a second I.F. transformer to a double-diode-triode which is resistance-capacity coupled to a high-efficiency output pentode.

The gramophone equipment has an automatic record-changer which enables up to eight 10-in. or 12-in. records to be played, repeated or rejected at will. An elliptical moving-coil loudspeaker is used, the features of which are non-directional sound transmission and high top-note response. (The cabinet dimensions are, height 38½ ins., width 47½ ins., depth 21⅝ ins.)

Refinements include a concealed lamp which flood-lights the television controls for purpose of adjustment, the switch for operations of this lamp being of the constant push-button

type. This model is designated the 703 and the price is 120 guineas, which includes a dipole aerial.

## Television Lectures

A special course of four lectures on television is to be given at the Regent Polytechnic, 309 Regent Street, W.1, commencing on May 31 next.

These lectures are to be given by that well-known technical authority on television, Mr. H. J. Barton Chapple. We advise readers to attend for Mr. Barton Chapple explains the theory of television in a very lucid manner.

## Cheap Components for the Experimenter

Messrs. Galpins Electrical Stores, 75 Lee High Road, S.E.13, have just issued a new list of bargains of all kinds suitable for the radio constructor and experimenter. Amongst some of the items are morse keys and buzzer sets, power resistances, current check meters, charging and lighting plants, metal chassis, transformers, loudspeakers, etc.

This list contains so many items that we cannot possibly give any true idea as to the range of components or to the cheapness of them so we advise readers to drop a card to Messrs. Galpin at the above address, who will send all details.

## A Low-loss Coupling Unit

A low-loss shaft coupling unit has been introduced by Messrs. A. F. Bulgin and Co., Ltd. This coupling has the spacing piece made of a special porcelain so that it is suitable for use in all types of high-frequency receivers and in transmitting circuits where high voltage is being handled.

Type E.H.12, with a 1-in. insulator, is priced at 1s. 9d., while type E.H.14, with a 2¼-in. insulator, is priced at 2s. 3d.

# RECENT TELEVISION DEVELOPMENTS

## A RECORD OF PATENTS AND PROGRESS *Specially Compiled for this Journal*

Patentees:—*J. C. Wilson and Baird Television Ltd.* :: *The General Electric Co., Ltd. and D. C. Espley* :: *Zeiss Ikon Akt.* :: *J. L. Baird and Baird Television Ltd.* :: *Baird Television Ltd. and C. Szegho* :: *Farnsworth Television Incorporated.*

### “Cross-ways” Scanning (Patent No. 459,178.)

INSTEAD of scanning the picture in a series of lines all of which lie in the same direction, the lines are arranged in groups, the direction and sense of all the lines within a group being the same, but being different in

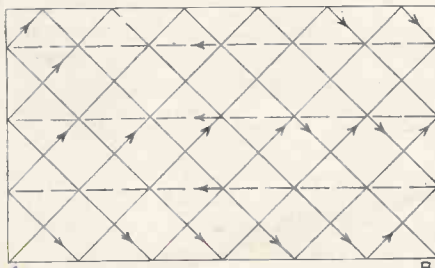

System of cross-ways scanning. Patent No. 459,178

different groups so as to give a cross-wise effect. In other words the picture is explored in a series of strips, the strips in different series lying in different directions, and one series at least lying in a direction inclined both to the horizontal and vertical axes of the picture.

This result is secured by using two time-base circuits, one generating saw-toothed oscillations, and the other producing waves substantially triangular in form. This causes the spot to start at the corner A and to follow the path indicated by the arrows, terminating at B.—*J. C. Wilson and Baird Television, Ltd.*

### Cathode-ray Tubes (Patent No. 459,963.)

It is sometimes convenient to earth the cathode of the tube. The screen end is then at a high positive potential to earth, and it is necessary to provide an electrostatic shield from neighbouring objects. This may be located inside the glass bulb, but it is easier from the manufacturing point of view to have it outside. In that case, of course, an extra shield is necessary in order to protect the user.

According to the invention the first

outer shield consists of a conducting layer of carbon formed on the external walls of the tube—stopping short of the fluorescent screen, whilst the second or “extra” shield consists of a metal case. The latter surrounds the tube and is held in place by insulating members which bear against the carbon layer on the outer walls.—*The General Electric Co., Ltd., and D. C. Espley.*

### Photo-electric Cells (Patent No. 460,012.)

A thin layer of antimony or bismuth is deposited from vapour on to a suitable backing, and after being oxydised, is mixed with a thin layer of caesium or rubidium, also vaporised, so that the metals form an alloy. The resulting layer, which is so thin as to be transparent, is highly sensitive to all light-rays, from red to violet.—*Zeiss Ikon Akt.*

### Scanning by Mirror-screw (Patent No. 460,197.)

In order to secure the effect of interlaced scanning, a mirror-screw is keyed to a driving shaft so that it is free to move slightly to and fro along the shaft whilst in rotation. This movement, which produces the necessary displacement from line to line, is imparted to the drum by a heart-shaped cam geared to the driving motor. The same result can be secured by imparting a vibratory movement to a mirror which is interposed between the mirror-screw and the observer.—*J. L. Baird and Baird Television, Ltd.*

### Cathode-ray Tubes (Patent No. 460,445.)

Instead of using a separate rectifier to supply D.C. voltage to the anode of a cathode-ray tube, the rectifier is incorporated in the tube itself. As shown, one winding,  $T_1$ , of the supply transformer  $T$  heats the filament  $F$ , whilst a second winding  $T_2$  is connected across the filament and the anode  $A$  of the tube. The anode  $A$  and indirectly-heated cathode  $K$  are shunted by a condenser  $C$  and resist-

ance  $R$ , the latter acting as a load across which the required D.C. voltage is built up. The inside surface of

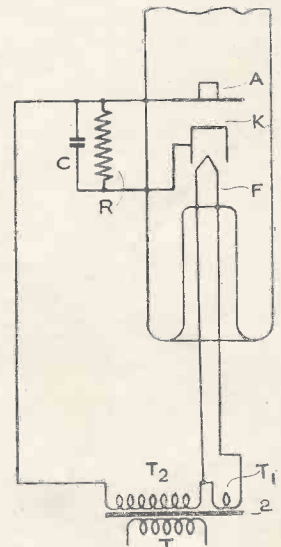

Combined rectifier and cathode-ray tube. Patent No. 460,445

the pot-shaped cathode  $K$  is coated with amorphous carbon to prevent emission, whilst the outer surface carries a highly-emissive substance, preferably one of the rare-earth oxides.—*Baird Television, Ltd., and C. Szegho.*

### Fluorescent Screens (Patent No. 460,479.)

Fluorescent materials are divided into two classes. The first, of which zinc borate is an example, only produces a very weak light unless it is “activated” by the addition of a foreign substance such as manganese dioxide. It then gives a brilliant response, but shows a time-lag effect, similar to that of phosphorescence.

The second class, of which zinc sulphide is an example, does not require any activating agent, and gives a practically instantaneous response. But it must be used in an exceptionally pure state, the presence of even minute particles of foreign matter

usually causing the intensity of fluorescence to fall off very considerably.

According to the invention, activated zinc borate is mixed with chemically-pure zinc sulphide, and the mixture is sprayed on to the inner glass surface of the bulb of a cathode-ray tube. The latter is then "processed" at a temperature lower than that at which the pure zinc sulphide can combine chemically with the material used to activate the zinc borate. The combination is stated to give a brilliant light, closely approximating to white.—*Farnsworth Television Inc.*

**Super-regenerative Sets**

(Patent No. 459,300.)

In order to secure a finer control over the "quenching" of a super-

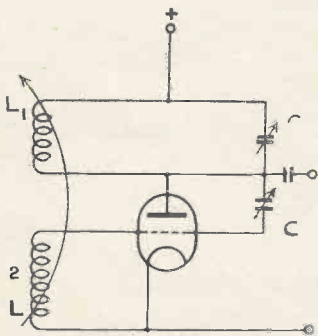

Method of securing fine quenching control. Patent No. 459,300.

regenerative valve, an auxiliary coupling condenser C is arranged in series with the grid coil L and the plate of the valve. (The plate coil L1 is back-coupled to the grid coil L, as usual, and is tuned by means of the condenser C1. The additional regulation of feed-back energy through the condenser C permits the valve to be used closer to the point of self-oscillation, where the amplifying action is most effective.—*L. R. Merdler, M. Scott, and Baird Television, Ltd.*

**Summary of other Television Patents**

(Patent No. 459,177.)

Method of scanning in groups of parallel lines, the inclination of each group of lines being periodically altered or "crossed."—*J. L. Baird and Baird Television, Ltd.*

(Patent No. 459,400.)

Combining saw-toothed and square-topped oscillations to give interlaced scanning.—*Farnsworth Television Inc.*

(Patent No. 459,422.)

Circuit for amplifying saw-toothed scanning oscillations in a strictly linear fashion.—*Radio-Akt D. S. Loewe.*

(Patent No. 459,506.)

Generating impulses of rectangular wave-form for synchronising in tele-

vision.—*J. C. Wilson and Baird Television, Ltd.*

(Patent No. 459,610.)

Time-base for a television receiver in which the potentials of both deflecting plates are varied in push-pull.—*The General Electric Co., Ltd., and D. C. Espley.*

(Patent No. 459,723.)

Television amplifier for handling all frequencies, down to zero, with substantial fidelity.—*T. M. C. Lance, P. W. Willans and Baird Television, Ltd.*

(Patent No. 459,735.)

Combining the output from two P.E. cells, so as to give uniform amplification in a television transmitter.—*The General Electric Co., Ltd., and D. C. Espley.*

(Patent No. 459,853.)

Preventing distortion due to the loss of D.C., or "zero" frequencies, in amplifiers used in television.—*E. L. C. White.*

(Patent No. 460,198.)

Automatic volume control system for a combined sound and picture receiver.—*L. R. Merdler and Baird Television, Ltd.*

(Patent No. 460,204.)

Intermediate-film method of receiving television pictures.—*T. E. Bray and Baird Television, Ltd.*

**"Photo-Electric Effects"**

(Continued from page 284)

The original form of rectifier cell consists of a layer of cuprous oxide on a copper plate forming one electrode. A conducting gauze placed in contact with the oxide serves as the second electrode and admits light to the oxide surface. Illumination results in the liberation of electrons in the oxide, which flow in one direction only, on account of the rectifying properties of the arrangement, and give rise to the current in the external circuit.

This type of cell has been described by Lange,\* while the theory of its operation has been worked out by Schottky† and also by Auwers and Kerschbaum.‡

Special methods for obtaining thin metallic films on copper oxide have been devised by Duhme and Schottky§ for producing a different kind of operation, in which the direction of current in the external circuit is opposite from that corresponding to the previous arrangement. In this case the light passes through the metallic layer before acting upon the oxide.

The effects of temperature in such cells have been examined by Teichmann,|| who finds that at + 6° Celsius

\* Phys. Zeits., 31, 1930, pp. 139, 964.

† Phys. Zeits., 31, 1930, p. 913.

‡ Anp. der Phys., 7, 1930, p. 129.

§ Naturwiss., 18, 1930, p. 735.

|| Zeits. für Phys., 65, 1930, p. 709 ; 67, 1931, p. 192.

there is a four-fold increase in sensitivity, whereas there is no sign of reduction of sensitivity down to the temperature of liquid air.

**The Electrical Encyclopedia**

One of the finest handbooks for the working electrician is the "Electrical Encyclopedia," published by The Waverley Book Co., Ltd., 96-97 Farringdon Street, E.C.4.

It is complete in four volumes and priced at 70s., but hire-purchase terms can be arranged so that the purchaser need only pay 2s. 6d. on the eighth day after he has had time to examine the volumes, after which further sums of 5s. have to be paid each month, concluding with a final payment of 6s.

The four volumes consist of 1,400 pages and include over 2,300 illustrations. The volumes are a fine source of information for the practical electrician, also as the theoretical side is most comprehensive it can be used as a standard book of reference.

The books have been compiled by no less than six expert editors and include the work of 32 qualified contributors under the general editorship of S. G. Blaxland Stubbs.

We strongly advise readers to write to The Waverley Publishing Co., Ltd., for the seven-day free examination offered; to all purchasers a 66-page pocket reference book of tables is being presented free.



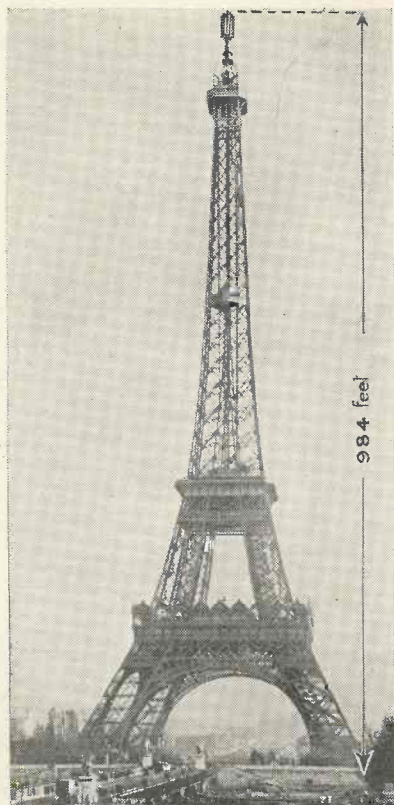

*The high-power transmitter is to be housed at the base of the Eiffel Tower.*

**E**XPERIMENTAL television transmissions from the Eiffel Tower have been taking place since December, 1935. These were with a definition of 180 lines and at 25 pictures per second, and it has generally been recognised that they were a stage in the process of development and not intended to provide a public service.

Another move has now been made, for an order has been placed for a new transmitter which will be the most powerful commercial television broadcasting installation in the world.

### 30 Kilowatts

This new transmitter has been commissioned from Le Materiel Telephonique, the French company associated with Kolster Brandes, Ltd., by the French Ministry of Posts, Telegraphs and Telephones. It will have a peak power of 30 kilowatts, fully modulated, in the aerial. The definition will be 405 lines, with a band width of 2.5 megacycles.

It is proposed to install the new transmitter at the base of the Eiffel Tower with the aerial projecting from the top of the flagpole, which is 984 feet above ground level. The trans-

# A SUPER-POWER TELEVISION TRANSMITTER FOR THE EIFFEL TOWER

## WILL THE PICTURES BE RECEIVABLE IN THIS COUNTRY?

mission cable from transmitter to aerial will be approximately 400 metres long, over 5 ins. in diameter, and will weigh about 12 tons. Of the semi-flexible coaxial type necessary for the high frequencies, it will run up the framework of the tower to the centre of the topmost cupola, from which the present flagpole protrudes.

### Special Problems Involved

The construction of the transmission cable has provided several novel and difficult problems. Since the cable is to pass upwards from the top of the framework of the tower it will be necessary to substitute a new hollow metal flagstaff for the present one. This, with the transmission conductor inside, will have to be pushed up through the opening in the collar that crowns the steel structure to a height of 12 metres above. The aerial will continue for a further vertical distance of three metres above the flag.

Another problem concerns the installation of the transmission cable between studios and transmitter. This will be accomplished by a specially adapted transmission cable with spe-

cial terminal equipment necessitated by the alternative systems of positive or negative control which require different characteristics in the transmission lines leading from the studios.

### Programme Arrangements

The equipment will include a monitoring set which will enable a technical operator to have full control, and to know at all times just what quality of television broadcast is going out on the air. The audible portion of the programmes will be put out from a regular P.T.T. broadcasting station. Programmes will be produced from two studios, situated in the Radio Building of the Exposition and the Post Office Building. Thus the Eiffel Tower, whose career began with the Exposition of 1889, is to play a leading rôle in one of the most ultra-modern features of the 1937 Exposition.

The contract just signed with Le Materiel Telephonique, in whose laboratories the equipment has been developed after two years' research, specifies that the new station shall be ready for service with reduced power



*The 30-kilowatt transmitter for the new Eiffel Tower station.*

by July 1 of this year, and operate with full power by the autumn.

In view of the aerial height, and the large power which is to be used, it is interesting to speculate whether the new station will be receivable in this country. Actually, even the south coast of England will be beyond optical range, but the experience which has been obtained in the case of Alexandra Palace transmissions shows that the optical range is exceeded in certain circumstances.

The diagram shows the optical range of the transmitter assuming a transmitting aerial height of 1,000 feet and a receiving aerial height of 60 feet. This can be worked out as follows:—

In the diagram  $r$  is the radius of the earth (approximately 4,000 miles),  $h$  and  $h'$  the heights of transmitting and receiving aerials, and  $d$  and  $d'$

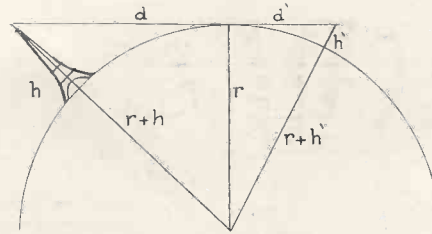

Diagram showing how the optical range of an aerial is calculated.

the horizon distance of transmitter and receiver respectively. It will be clear that

$$d^2 + r^2 = (r + h)^2$$

$$d^2 = 2rh + h^2, \text{ neglecting } h^2$$

we have

$$d = \sqrt{2rh}$$

$$= \sqrt{8,000h} \text{ miles.}$$

Similarly  $d' = \sqrt{8,000h'}$  miles.

In the case of an aerial height of

1,000 feet it will be seen that the horizon for this aerial is approximately 39 miles. To this must be added the horizon distance of the receiving aerial which, assuming a height of 60 feet, will be roughly  $9\frac{1}{2}$  miles. The total horizon distance will therefore be  $39 + 9\frac{1}{2} = 48\frac{1}{2}$  miles.

As the distance from Paris to the nearest point on the south coast of England is roughly 170 miles, it does not appear, assuming the range is quasi-optical, that the transmissions will be receivable in this country, but short-wave reception is full of surprises and it would be a mistake to make any pronouncement on the matter until actual experience has been obtained. Certainly if these transmissions were receivable in the southern parts of England, they would provide an immense fillip to television.

## COLUMBIA PLANS HUGE TELEVISION STATION

THE Columbia Broadcasting System (U.S.A.) has applied to the Federal Communications Commission for permission to construct one of the world's most powerful combined television and sound transmitters at the top of the Chrysler Building in New York City.

When fully modulated the proposed station will operate at a peak power of 30 kilowatts, which is equal to that of a transmitter soon to be constructed on the Eiffel Tower in Paris.

### The Transmitter

The transmitter, which is to be located on the 74th floor of the skyscraper, will incorporate the latest developments in high-power wide band design. Because it will operate on a frequency somewhere between 42 and 56 megacycles—it is expected that the station will have a range of approximately 40 miles over a total area of about 4,800 square miles.

The aerial is to be built around that portion of the building immediately below the stainless steel needle surmounting it. This will mean that a distance of less than 100 feet and separates the transmitter from the aerial and, therefore, that an almost distortionless transfer of power should be assured.

The Chrysler Tower was chosen as the best location for the transmitter after an exhaustive study of the whole New York skyline within a radius of

one mile from that point, according to Dr. P. C. Goldmark, who is at the head of Columbia's television research department.

Experiments conducted by C.B.S. engineers disclosed that the height of the aerial was not the only thing to be considered. The fact that most of Manhattan's population is concentrated to the north of the tower, and that no higher buildings are located in that direction, was of prime importance in selecting the site. (This situation indicates that the radio waves will not be broken up or refracted by the steel skeletons of other skyscrapers, and that therefore the production of double images will be avoided.)

Columbia is not a newcomer in the television field, but is merely continuing experiments started many years ago. After the transmission of low-definition pictures over W2XAX, five years ago, elaborate research was pushed by C.B.S., both in America and abroad. The comparison of such experimental work with that done by the British Broadcasting Corporation as well as other radio

organisations here and abroad led to findings which make possible the construction of the new station.

The Columbia Broadcasting System was among the earliest pioneers to undertake practical experiments in television in the States. In 1931, after extensive laboratory research in the United States, it was believed the time was ripe for broadcasting of images via the ether, Columbia was the first broadcasting company to transmit sight and sound simultaneously from the same transmitter.

Columbia started the first regular television broadcasts in the United States, continuing them from 1931-1933. During that time what are technically known as low-definition, 60-line pictures were transmitted daily on a frequency of 2,800 kilocycles. These were discontinued in 1933 because it was appreciated the pictures had little entertainment value.

Since 1933, the C.B.S. engineers have carried on intensive research on the requirements of high-definition television.

The present transmitter will operate on a 441-line basis as compared to the 60-line images of 1931 and 1933. In addition the new transmitter will produce 60 pictures a second, as compared with 20 pictures a second in the earlier television broadcasts. The maximum frequency of the new transmitter will be 2,500 kilocycles.

**OUR POLICY**  
*The Development*  
of  
**TELEVISION**

## STUDIO SCREEN

## A MONTHLY CAUSERIE

on  
Television Personalities  
and Topics

by K. P. HUNT

Editor of "Radio Pictorial"

OUTSTANDING among the many enthralling television programmes devised by the B.B.C., none has aroused such general interest and expectancy as the forthcoming vision broadcast of the Coronation Procession, which is to take place on May 12. Here is a broadcast the successful achievement of which assuredly will find a permanent place in the world's history books of television.

In these notes last month I was able merely to indicate the B.B.C.'s television arrangements for the Coronation in a vague manner, but I hazarded a guess that although at that time the exact location of the television cameras was not disclosed, the site when known would immediately be recognised as the most suitable one possible.

It has since been announced that the B.B.C. has chosen Apsley Gate, Hyde Park Corner, which really is a splendid position. This site was selected, I am told, because after a careful consideration of the entire route which the Procession will take, this particular point conferred the most comprehensive view of the Procession approaching and departing.

A decision has now been made to use three cameras: one will occupy a special platform beside the plinth of Apsley Gate; while the other two will be operated from pavement level, one on the south side of the arch and the other on the north side.

Camera No. 1 will look along East Carriage Drive, which is parallel to Park Lane, and thus the lens will embrace in its view a very long distance, which will be an ideal arrangement for seeing the approaching Procession. In case some readers may not recall the environs of Apsley Gate, I should explain that the base of the columns of the Gate is well raised, and offers a fine commanding view. I do not think any more appropriate site could have been selected, because, in the way that the cameras are now going to be arranged, viewers will have a wide sweep of view in both directions.

Camera No. 1 will, therefore, show a sort of panoramic view of the approaching procession, and will be facing north.

Camera No. 2 will also be installed on the opposite side facing south, and thus will give a rear view of the procession as it wheels across Piccadilly towards Green Park and Constitution Hill.

Camera No. 3, with which it is hoped to obtain a number of close-up views of the procession as it passes through the arch, will be supported in the usual way on a tripod on the pavement.



*Freddie Grisewood will give the commentary in the B.B.C.'s television programme of the Coronation Procession.*

The actual programme will last approximately one hour, and is scheduled to begin at 2 p.m. Exact times cannot be given, of course, but the probable arrangement of the programme will be that in the first ten minutes general crowd scenes will be broadcast, together with a commentary, but it is expected that the procession will reach Apsley Gate in the region of 2.10 p.m. It is probable, owing to the length of the procession and the relatively slow speed at which it will travel, that it will take fully fifty minutes for the procession to pass any given point.

Their Majesties doubtless will be towards the end of the procession and are expected to pass the television

cameras very approximately at 2.45 p.m.

\* \* \*

Honour of being the B.B.C. commentator on this momentous occasion has fallen to Freddie Grisewood, the well-known London sound broadcast announcer whose cheery "Goodnight" is familiar to millions of listeners. Some surprise naturally has been expressed that the Ally Pally television staff—who have been specially trained in television work—appear to have been superseded on this important occasion with no apparent advantage.

The general public naturally will evince considerable interest in the television cameras at Apsley Gate, and I can reveal that effective measures have been taken to safeguard the instruments from excessive curiosity.

What few of the crowds of on-lookers may know, however, is that the cameras themselves constitute only half of the story.

Concealed some 200 yards away from Apsley Gate, on the green sward adjoining Rotten Row, will be the three quite ordinary looking motor vans which constitute the B.B.C.'s first television O.B. unit. There will be a cable, of course, connecting the cameras to the unit.

The vans will be stationed at a point where the special high frequency cable, referred to in these notes last month, ends. (This cable is housed underground in the existing Post Office telephone conduits, the route taken from the point near Apsley Gate being along Park Lane to Marble Arch, thence by Oxford Street to Broadcasting House. Broadcasting House has another cable connecting it with Alexandra Palace.)

It is by no means certain that the cable will be used for this important broadcast, and in any case there will be the new wireless link as a standby.

\* \* \*

I think I can safely prophesy that this new mobile television unit, which obviously has such great possibilities, is destined to play a very prominent part in the television programmes of

## TELEVISION TRANSMISSION TRICKS

the near future. Already, its use in providing viewers with the often proposed "Seeing the Derby from the Armchair" is again being seriously discussed, and indeed is a distinct possibility for this year's great classic race.

\* \* \*

At the time of writing these notes, I understand that the mobile unit has not yet been delivered to the B.B.C. It is being made by the Marconi people at their Hayes works, and I believe the delivery date arranged is only a few days before the Coronation. I am told that everything is working to schedule, and that the three vans will certainly be delivered and the whole apparatus tested and in working order on time.

\* \* \*

Various statements have appeared in the lay Press as to the cost of this unit, many of which have been quite wide of the mark. I was told authoritatively a few days ago that the cost is in the region of £40,000.

Van No. 1 will contain the scanning equipment, van No. 2 the generators and amplifiers, while van No. 3 will house the ultra-short wave transmitter. The transmission will take place from a standard dipole aerial on the roof of van No. 3. This will be of the collapsible type and will be erected for use as required.

It is interesting to note that this mobile television transmitter will employ a wavelength of the order of 3.5 metres.

\* \* \*

As I write these notes I hear that a new producer solely in charge of O.B. vision broadcasts has just been appointed. He is Mr. Moultrie Kellsall, and comes from Aberdeen with an impressive record.

If these vans are used for the Coronation, the broadcasts from the mobile unit will be picked up direct at Ally Pally and re-broadcast. In anticipation of this, a new receiving aerial is now being put up and doubtless will be complete before these notes are in print. At the moment, only the mast has been erected right on top of the existing aerials. The new aerial is of the dipole type and will tower about 20 feet above the others. The aerial mast at Alexandra Palace therefore will now support three aerials, the lowest being for the transmission of sound, the middle one for the transmission of

vision broadcasts, while the new one on top will be the new receiving aerial which incidentally will be the highest ultra-short wave receiving aerial in the country.

Preparations are being pushed on hurriedly at Alexandra Palace to ensure the best possible reception from the mobile unit and for rediffusion via the usual transmitter. I understand that the receiver to be used has been designed by the Marconi-E.M.I. Company, and will be housed in a little room over the tele-cine room above the studio floor.

It is generally felt at the Palace that the introduction of this mobile unit is likely to bring about the most impressive improvements in the television programme since they began last November, and its employment will be watched with great interest.



*Elizabeth French the Covent Garden opera singer, has appeared in many television programmes.*

I referred last month to the use of what might be called "trick" photography in television production, and some further amazing and exceedingly clever instances have occurred in the past month. On March 31, being the eve of April Fools' Day, "Picture Page" was transformed into a sort of "crazy page," as suited the occasion. A dreadful hitch occurred! Leslie Mitchell, the popular television announcer, came on with eyes glazed with apprehension. Where were the artists? What had gone wrong?

Suddenly, looming up on the screen, came a ghostly figure clad in Victorian clothes complete with topper.

Said the eerie visitor to Leslie in frigidly formal tones: "I gather, young man, this is some kind of fes-

tive entertainment." The theme was considerably elaborated and proved a fine example of trick effects.

Early in April another case occurred which must have caused many viewers to wonder how the effect was accomplished. This was in an excellent programme on April 12, entitled: "Cabaret Cruise," which, by the way, was one of Harry Pringle's greatest triumphs to date. In this programme a ship was seen to be gently rocking with the swell on the waves.

Now I can tell you definitely that the stage was not being rocked. The set with the actors upon it also was quite rigid. The camera itself was not rocked.

How, then, was the ship as seen on the receiving screen made to sway as by waves? I will give you three guesses!

You will be surprised at the clever manner in which this was achieved. It was an inspiration on the part of one of the senior studio engineers. The camera did not directly photograph the set at all, for what viewers saw on their screens was a photograph of a reflection of the set-piece. The camera itself was looking at right angles to the set, and pointing towards a small mirror inclined at an angle of 45 degrees to the axis of the camera in such a way that it reflected to the camera a full picture of the set. This device, of course, was not discernible on the viewing screen, and it appeared that viewers were looking at the ship directly.

The intermediate mirror was mounted flexibly so that it could sway, and a slight movement to and fro was arranged by the periodic pulling of a wire against a spring, the oscillatory movement being governed by a gramophone motor. Thus the mirror was given a slow but regular seesaw displacement, which in turn slightly shifted the reflection of the ship, which was seen by the television camera and transmitted to the viewers. The result was a perfect simulation of the movement of the ship as by the waves. A really clever piece of work.

\* \* \*

The programme entitled: "Fugue for Four Cameras," by Stephen Thomas, with Maude Lloyd as the dancer, which I mentioned last month, will be repeated on May 1, and those who did not see it when

## ITEMS IN FUTURE PROGRAMMES

it was broadcast early in March should not miss it this time.

I notice that Rita Grant has come into the television limelight again. She was the girl who was televised at the first Press reception at Ally



*Alex Moore and Pat Kilpatrick who give the dance lessons via television. They are shortly to be married.*

Pally. Rita was three years with C. B. Cochran and in 1935 was a *Daily Mail* beauty winner, and should have a bright future in television.

Gerald Cock, the television chief, is making a notable effort to put out some really strong programmes during Coronation week, but I have space here only to indicate some of the high lights.

On Monday, May 10, replicas of the crown jewels will be broadcast, while on May 11 a special Coronation edition of "Picture Page" is being staged. The usual 3 p.m. to 4 p.m. programme on Wednesday, May 12, will of course be replaced by the slightly earlier Coronation programme mentioned above; but at 9 p.m. on Wednesday, Harry Pringle will be in charge of a special variety performance which I gather will be after the lines of the "Old Music-hall Memories" popularised in sound broadcasting by Wilson Dissher.

On Thursday, May 13, a notable contribution to "Starlight" will be made by Clapham and Dwyer, the famous comedians; while on Friday, May 14, the outstanding feature will be the second television performance of Jack Hylton and his band, which is scheduled to occupy 25 minutes.

Jack Hylton's appearance early in April was a great success. The band consisted of 24 pieces, six vocalists, including Peggy Dell and Alice Mann, Fred Schweitzer in comedy, and Joe

Rossi, the boy wizard of the accordion, not forgetting Jack himself, who is an incomparable showman. In discussing the televising of dance bands nine months ago, I ventured to prophesy that as soon as Jack Hylton and Jack Payne were given a chance they would quickly establish themselves ahead of all others in this new field. (They are without competition as show bands, as distinct from mere sound broadcasting bands, and accordingly I am looking forward personally to seeing Jack Hylton's programme on May 14, which from the purely entertainment standpoint should be one of the best yet radiated from the Palace.

\* \* \*

Cinemagoers have now become quite familiar with the backstage type of film which takes you behind the scenes of theatres and the film studios, and it was not to be expected that long would elapse before our television producers took a leaf from the same book. So on Saturday, May 15, we are to have the first show which televises television. This will be a backstage affair in which viewers will be taken around the studios, into the dressing rooms, and shown exactly how a show is produced. We shall even go down to the Ally Pally restaurant and see someone having a nice cup of tea.

A good deal of comment has been made during the month about the B.B.C.'s lack of funds for the development of the television service. In some places it has been suggested

that wireless licences in future may be increased to 12s. 6d. to provide for the additional expenditure. I am authoritatively told there is no truth whatever in this suggestion, which



*Dennis Van Thal appears in Reggie Smith's "Queen for Song" shows which are now a regular Saturday feature in television.*

obviously would be very unfair to the listeners at present residing outside the television reception area.

#### 5-Meter Tests from Ashurst Beacon

On May 2, G2IN and G5ZI will be transmitting phone and modulated C.W. on the 5-metre band with directional and non-directional aerials.

Transmissions start at 10.00 B.S.T. and continue without break until 16.00 B.S.T. Transmitting and listening stations are asked to co-operate and to fix schedules so that there will not be any loss of listening time. Details from G2IN.



*Public interest in television is apparent from this photograph taken outside the G.E.C. showrooms in Kingsway.*

# MORE PROGRAMME IDEAS AND CRITICISM

Here are some further letters containing suggestions and criticisms for which we asked in our February and March issues.

## ADDING VISION TO BROADCASTING

Sir,

The natural application of television is (a) as an aid to sound broadcasting, and (b) as a means of looking in on something which happens to be occurring at some distant place.

The B.B.C. have taken an opposite point of view and are endeavouring to use television as a separate entertainment channel. Think what this means in programme building: They are finding it difficult already to always find suitable material, and the result is a lot of very boring padding.

Entertainment brought to the camera must be of such quality and so full of lively interest that the viewer is lost to the fact that it is a televised programme. We have had about half a dozen such programmes.

As an aid to sound we want television "piped" from B.H. and St. George's Hall to show us the comedian's grimaces, the effect of which we can already hear; to give us the conductor of a symphony orchestra to help concentration; and to show us the actors in radio drama. The boxing broadcast from the "A.P." concert hall showed us the difference between real television and studio entertainment. There was a thrill in the real thing.

## DRAMA

Until the O.B. apparatus is ready, however, studio production must go on. Good variety turns are welcome. Persons interviewed in "Picture Page" must be well known for their art, skill, profession or something they do and they should for that reason give examples in their interview; we are not interested in seeing just faces. The "London Character" type of subject is not, generally speaking, of much interest.

Slow moving and heavy items do not hold the attention sufficiently for television. Films of good entertainment value could always be used to swell programmes, or excerpts linked up with a commentary to make a story.

Films should not be repeated within months. Most of the films televised to date have been very poor.

Instead of giving the same news reels twelve times per week, cannot the B.B.C. have a news camera man out filming items daily—giving delayed television in effect?

More televised drama is required.

As regards times, traders will want the afternoon transmissions, and in the evenings, although more is desired, it should be in two sessions. The actual timing should be arranged in conjunction with televisable sound programmes.

L. Bounds (Hillingdon).

## MORE FILMS

Sir,

The recent extension in "direct" television transmissions made possible by the development of the Emitron camera, appear to have placed the film, as a means of televised entertainment, in a somewhat inferior position.

Interesting and desirable as studio and outside broadcasts are, I should like to see the full length dramatic feature film given its proper place in future programmes and suggest that these inclusions would be a practical method of providing an immediate extension of the service without prohibitive cost.

Many of us regret the very limited opportunity we have of seeing for a second time films of a year or so ago and the many good productions that we have missed from time to time. These films produced at great cost and upon which so much time and thought have been expended, have their two or three weeks run and then, apart from a few exceptional revivals and some Sunday showings, are heard of no more.

Here then exists a storehouse of ready-made entertainment of infinite variety and definite appeal. Does it not seem desirable that the best of these forgotten films should be brought to light in order to entertain us once more?

It may be argued that the film companies will not readily concede that such a policy would prove beneficial to them, but I am of the firm opinion that the re-issue of out-of-date films for television purposes would not in any way harm the film industry, but rather provide an additional source of revenue and foster an even greater appreciation of the screen.

As an enthusiastic film goer, I believe the introduction of well chosen re-issue feature films into television programmes will prove a great incentive to others of that great army, to possess a television receiver. Let us therefore do all in our power to further such an ideal, for the future development and ultimate perfection of television must to a great extent depend on the support given by the public to those whose untiring effort and tenacity of purpose have demonstrated that television has arrived.

Frank S. Wise (London, W.C.).

## THE GRAMOPHONE PARALLEL

Sir,

As an enthusiastic viewer and constant reader of your journal, I have for some time been wishing to express my opinion of the television programmes and feel that here is an opportunity.

In view of the fact that most of the sets now working are used by demonstrators, the number used by home viewers being very small, I suggest a more suitable time for transmissions be, say, between eight and nine p.m. This would obviate the necessity for demonstrators returning to their premises after ordinary business hours in order to allow their interested clients, who, for business reasons, are unable to call during the afternoon, to view transmissions. I consider the length of programmes, at present, quite adequate, but hope the number of hours will be at least doubled—should suggest four separate hours—as soon as the service becomes established.

In my opinion there is no entertainment value in pictures televised more than twice, and would abolish educational films dealing with insects, etc. I would

(Continued on page 316)

## More Programme Criticisms (Continued from page 292)

substitute travel films. Through the medium of films comes our best pictures, therefore, I suggest the programmes department should collect a number of short cabaret films and use them as Broadcasting House would use gramophone records.

My ideal programme would be :—

- An O.B. topical event.
- News reel.
- Variety act, or one act play.
- Travel film.
- Picture Page.

J. J. Smith (Eltham).

### THE TASK OF THE B.B.C.

One could advance the following reasons for public apathy towards television. *Firstly*, the television programmes from Alexandra Palace have proved comparatively dull and uninteresting. This should not be taken as implying criticism of Gerald Cock and his assistants, who are doing their very best to provide real television entertainment. One cannot however forget that it is an entirely new medium of entertainment, which requires the development of a technique of its own. Moreover, any really interesting television entertainment is bound to be costly and from the point of view of the B.B.C. unremunerative for a good few years to come.

A considerable increase in the financial appropriation for television in the B.B.C. budget will have to be made. One cannot feed lookers for very long on such items as how to carve a turkey, how to mend a window-pane, or on bird-life at the Zoo, and the like.

*Secondly*, a shortage of viewing hours. At present there are only twelve viewing hours a week, half of which come between three and four in the afternoon, when the master of the house must be somewhere at his business, and when the mistress of the house is likely to be either out shopping or attending a tea-party. Since for some unfathomable reason Sunday television is considered to be sacrilegious, the consumer is at present offered a television programme for only *six hours* a week, out of which he may have real entertainment value for about *ten minutes* every hour.

*Thirdly*, whatever programme is offered, the looker has to view it on a *small screen*, average size 8 in. by 10 in., there being only one firm whose screen is somewhat larger, i.e., 9 in. by 12 in. After all, our standards for pictures are set by the cinemas and the home ciné.

*Last*. A step in the right direction was made by the reduction, after the abolition of the second standard, of receiver prices to about 55 to 60 guineas. Of course, one may say that £55 to £60 is still rather a high price. Remembering, however, that there was quite a good market for radio-gramophones in the first years at a similar price, and also for home cinema equipment (comprising camera and projector), where, apart from the initial outlay, there is a constant recurring expenditure, and for high-class cameras such as Leica, Zeiss-Contax, etc., one would be inclined to think that *even at the price of 55 to 60 guineas there should be room for many thousands of television receivers*.

If that is not the case to-day, the reason can only be two-fold : (1) the *inadequate entertainment value* of the B.B.C. programmes, coupled with a shortage of viewing

hours, and (2) the *inadequacy of the size of the viewing screen*.

The first is a matter for the B.B.C. and one can definitely look forward to a gradual improvement in the programme, and to an increase in the number of viewing hours.

S.C. (London).

Sir,

The real problem, obviously, is to provide the non-technical masses with a television receiver giving a good, clear picture and costing not more than £25 in its cheapest form. This, I believe, can be done, but not with the present system. I have *not* followed the progress of television for the past eight years, except to pick up the scraps of information(?) broadcast from time to time in the lay press. Nevertheless, these scraps have been sufficient to give me a fairly good idea of what I should see on the screen of a receiver. They have also told me that line scanning is still in use, and as I have a ten year-old theory that line scanning is an unnecessary complication, I was not particularly interested. On Monday of this week I happened to see your January publication of "Television" and purchased a copy (I have, of course, obtained the February edition). A brief perusal of these two papers confirms my original views that *it is possible to pick up, transmit and reproduce a complete picture*, instead of a series of spots, as is now the case. The amount of skill and ingenuity which has been, and is being, put into the perfection of line scanning, reflects great credit on the people who have brought the science to its present stage; but I am bound to say that I believe the research has been directed into the wrong channel.

I do not propose to deal here with the technical side of complete picture transmission, except to say that a mere glance at the Philco and Marconi-E.M.I. camera diagrams convinces me that my original theory is correct and that we may hear at any moment that someone has put the idea into practice. The consequent discarding of the time-base and its attendant evils, will simplify and cheapen the receiver considerably. The type of cathode-ray tube I have in mind should certainly be retailed at not more than £5 if it could be produced in sufficient quantities. I do not think there is much doubt about the sale of quantity if the price is right.

In conclusion I would reiterate that the "flaws" in the programme will automatically be righted when there are sufficient "ordinary people" with satisfactory apparatus. Until then let the B.B.C. concentrate on transmission and reception of a high standard and within reach of the general public.

Leonard Seaborn (London, N.).

### Short-wave Programmes from Australia

The following schedules have been arranged for the Australian stations, Sydney and Melbourne, for the month of May.

Sydney, VK2ME.

Sundays—06.00-08.00 G.M.T.

Sundays—10.00-14.00 G.M.T.

Mondays—14.30-16.30 G.M.T.

Melbourne, VK3ME.

Monday to Saturday—09.00-12.00 G.M.T.

The wavelength of Sydney is 31.28 metres, and that of Melbourne, 31.5 metres.